

# HC-BB18-I-CT-F - Contact insert



1584729

<https://www.phoenixcontact.com/us/products/1584729>

Please be informed that the data shown in this PDF document is generated from our online catalog. Please find the complete data in the user documentation. Our general terms of use for downloads are valid.

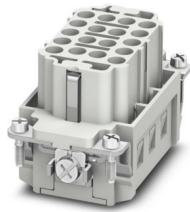

Contact insert, number of positions: 18+PE, size: B10, number of connections per position: 1, Socket, Crimp connection, 500 V, 16 A, 0.5 mm<sup>2</sup> ... 4 mm<sup>2</sup>

## Your advantages

- For fast coding with plastic profile (Order No. 1410916, type CP-HC-S)
- Shock and vibration-resistant in accordance with DIN EN 61373

## Commercial data

Item number	1584729
Packing unit	1 pc
Minimum order quantity	1 pc
Sales key	BF61
Product key	AF7ABD
GTIN	4046356149242
Weight per piece (including packing)	53.7 g
Weight per piece (excluding packing)	53.4 g
Customs tariff number	85366990
Country of origin	CN

# HC-BB18-I-CT-F - Contact insert

1584729

<https://www.phoenixcontact.com/us/products/1584729>

## Technical data

### Mounting

Assembly note	To ensure correct use, installation in housing with IP54 protection or better is required
---------------	---

### Product properties

Product type	Contact insert with a fixed no. of positions
Series	HC-BB
Type	B10
Number of positions	18
Connection profile	18+PE
Contact numbering	1 - 18
Number of connections per position	1
Contact material type	turned

### Insulation characteristics

Overvoltage category	III
Degree of pollution	3

### Dimensions

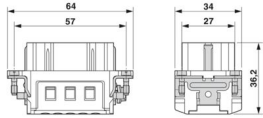
Dimensional drawing	
Width	34 mm
Height	32.5 mm
Length	64 mm
Drill hole distance, horizontal	57 mm
Drill hole distance, vertical	27 mm

### Mechanical characteristics

Minimum housing height	72 mm
Contact diameter	2.5 mm

### Connection data

#### Connection technology

Connection technology	Crimp connection
Number of connections per position	1
Connection in acc. with standard	IEC / EN

#### Conductor connection

Conductor cross-section	0.5 mm <sup>2</sup> ... 4 mm <sup>2</sup>
Connection cross section AWG	20 ... 12

# HC-BB18-I-CT-F - Contact insert



1584729

<https://www.phoenixcontact.com/us/products/1584729>

Tightening torque	0.8 Nm ... 1.2 Nm (PE connection)
	0.5 Nm ... 0.8 Nm (Mounting screws for mounting in the HEAVYCON housing)
Stripping length of the individual wire	7.5 mm

## Electrical properties

Rated voltage (III/3)	500 V
Rated surge voltage	6 kV
Rated current	16 A

## Mechanical properties

### Mechanical data

Insertion/withdrawal cycles	≥ 500
-----------------------------	-------

## Material specifications

Flammability rating according to UL 94	V0
Contact material	Copper alloy
Contact surface material	Ag (alternatively Au)
Contact carrier material	PC
Standards/regulations	PC

## Environmental and real-life conditions

### Ambient conditions

Ambient temperature (operation)	-40 °C ... 125 °C (including heating up of contacts)
---------------------------------	--

## Standards and regulations

### Testing

Standards/regulations	PC: Fire protection in rail vehicles - requirement sets R22, R23, and R24 acc. to DIN EN 45545-2 (Risk level HL1 - HL3)
-----------------------	---

# HC-BB18-I-CT-F - Contact insert

1584729

<https://www.phoenixcontact.com/us/products/1584729>

## Drawings

Dimensional drawing

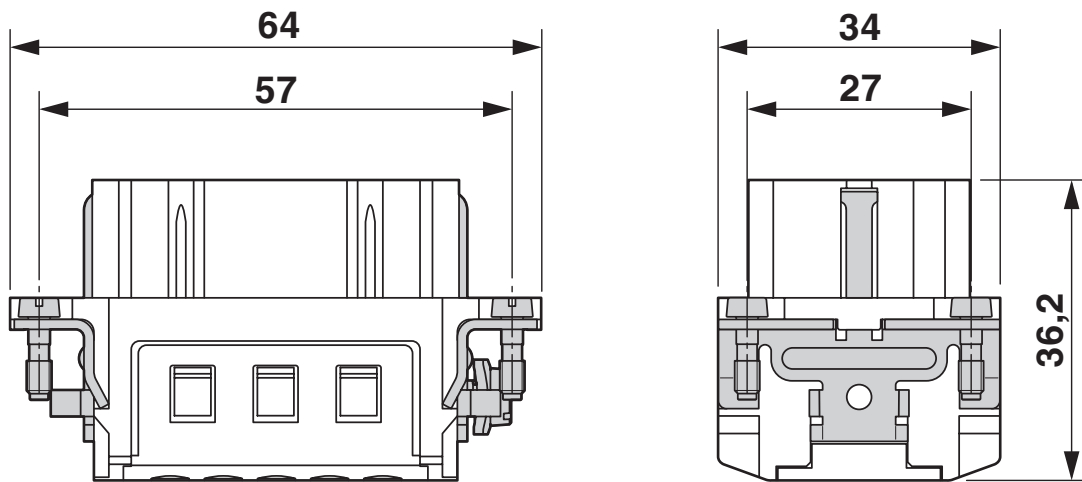

Female insert

Dimensional drawing

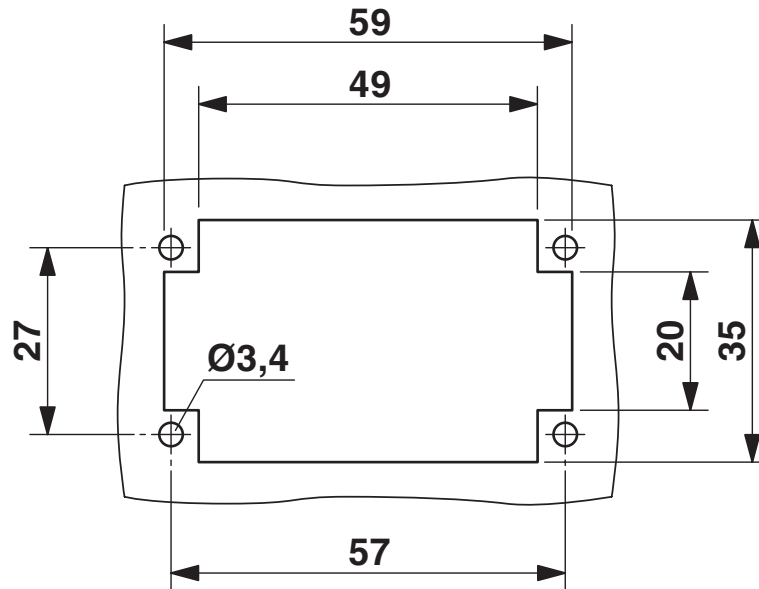

Mounting cutout when used without housing

# HC-BB18-I-CT-F - Contact insert

1584729

<https://www.phoenixcontact.com/us/products/1584729>

## Schematic diagram

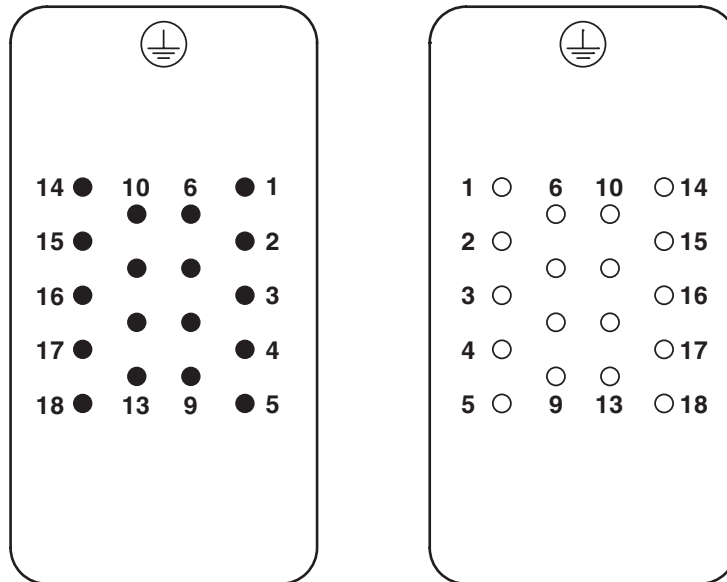

Connector pin assignment: Left pin - right socket

## Schematic diagram

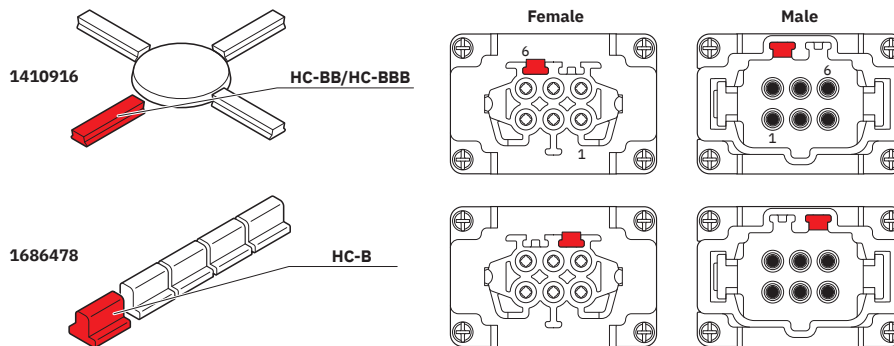

Coding options

# HC-BB18-I-CT-F - Contact insert

1584729

<https://www.phoenixcontact.com/us/products/1584729>

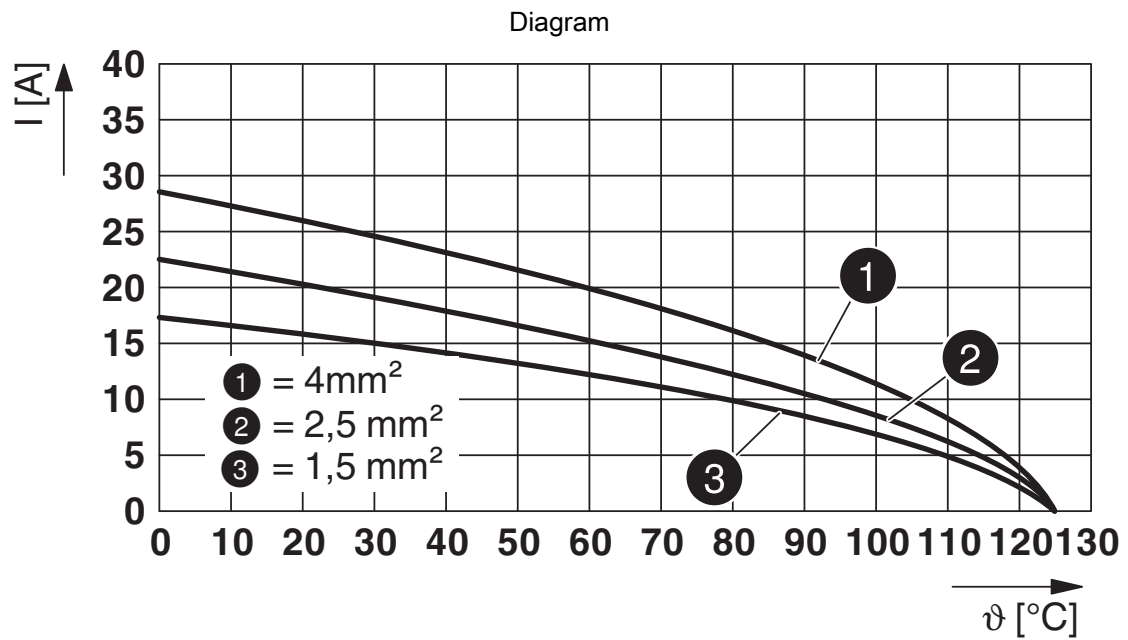

Derating diagram

# HC-BB18-I-CT-F - Contact insert



1584729

<https://www.phoenixcontact.com/us/products/1584729>

## Approvals

To download certificates, visit the product detail page: <https://www.phoenixcontact.com/us/products/1584729>

### DNV

Approval ID: TAE000037S



### CSA

Approval ID: 013631\_0\_000

	Nominal voltage $U_N$	Nominal current $I_N$	Cross section AWG	Cross section $\text{mm}^2$
keine				
	600 V	16 A	- 12	-



### UL Recognized

Approval ID: E118976

	Nominal voltage $U_N$	Nominal current $I_N$	Cross section AWG	Cross section $\text{mm}^2$
keine				
	600 V	20 A	- 12	-



### UL Recognized

Approval ID: E468743

	Nominal voltage $U_N$	Nominal current $I_N$	Cross section AWG	Cross section $\text{mm}^2$
keine				
	600 V	16 A	-	-

# HC-BB18-I-CT-F - Contact insert



1584729

<https://www.phoenixcontact.com/us/products/1584729>

## Classifications

### ECLASS

ECLASS-13.0	27440205
ECLASS-15.0	27440205

### ETIM

ETIM 10.0	EC000438
-----------	----------

### UNSPSC

UNSPSC 21.0	39121500
-------------	----------

# HC-BB18-I-CT-F - Contact insert



1584729

<https://www.phoenixcontact.com/us/products/1584729>

## Environmental product compliance

### EU RoHS

Fulfills EU RoHS substance requirements	Yes, No exemptions
---	--------------------

### China RoHS

Environment friendly use period (EFUP)	EFUP-E
	No hazardous substances above the limits

### EU REACH SVHC

REACH candidate substance (CAS No.)	No substance above 0.1 wt%
-------------------------------------	----------------------------

Phoenix Contact 2026 © - all rights reserved  
<https://www.phoenixcontact.com>

Phoenix Contact USA  
586 Fulling Mill Road  
Middletown, PA 17057, United States  
(+717) 944-1300  
[info@phoenixcon.com](mailto:info@phoenixcon.com)