

# SAC-4P-M12MS/ 1,5-511/M12FS FB - Sensor/actuator cable



1552641

<https://www.phoenixcontact.com/us/products/1552641>

Please be informed that the data shown in this PDF document is generated from our online catalog. Please find the complete data in the user documentation. Our general terms of use for downloads are valid.



Sensor/actuator cable, 4-position, Special mixture on PVC base, black RAL 9005, Plug straight M12, coding: A, on Socket straight M12, coding: A, cable length: 1.5 m, for the food industry, with high-grade steel knurl

## Commercial data

Item number	1552641
Packing unit	1 pc
Note	Made to order (non-returnable)
Sales key	BF03
Product key	AF1CCA
GTIN	4046356155984
Weight per piece (including packing)	80.5 g
Weight per piece (excluding packing)	78.2 g
Customs tariff number	85444290
Country of origin	DE

# SAC-4P-M12MS/ 1,5-511/M12FS FB - Sensor/actuator cable



1552641

<https://www.phoenixcontact.com/us/products/1552641>

## Technical data

### Product properties

Product type	Sensor/actuator cable
Application	Food processing industry
Number of positions	4
No. of cable outlets	1
Shielded	no
Coding	A

### Insulation characteristics

Overvoltage category	II
Degree of pollution	3

### Material specifications

Flammability rating according to UL 94	HB
Seal material	NBR
Material of grip body	TPU, hardly inflammable, self-extinguishing
Contact material	CuSn
Contact surface material	Ni/Au
Contact carrier material	TPU GF
Material for screw connection	Stainless steel

### Electrical properties

Insulation resistance	$\geq 100 \text{ M}\Omega$
Nominal voltage $U_N$	48 V AC
	60 V DC
Nominal current $I_N$	4 A

### Mechanical properties

#### Mechanical data

Insertion/withdrawal cycles	$\geq 100$
-----------------------------	------------

### Signaling

Status display	no
Status display present	no

### Connection data

#### Conductor connection

Tightening torque	0.4 Nm (M12 connector)
-------------------	------------------------

### Connector

#### Connection 1

# SAC-4P-M12MS/ 1,5-511/M12FS FB - Sensor/actuator cable



1552641

<https://www.phoenixcontact.com/us/products/1552641>

Type	Plug straight M12
Number of positions	4
Coding type	A

## Connection 2

Type	Socket straight M12
Number of positions	4
Coding type	A

## Cable/line

Cable length	1.5 m
--------------	-------

## PVC black FDA [511]

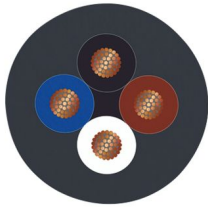
Dimensional drawing	
Number of positions	4
Shielded	no
Cable type	PVC black FDA [511]
Conductor structure signal line	42x 0.10 mm
AWG signal line	22
Conductor cross-section	0.34 mm <sup>2</sup>
Wire diameter incl. insulation	1.52 mm ±0.05 mm
External cable diameter	5.20 mm ±0.2 mm
Outer sheath, material	Special mixture on PVC base
External sheath, color	black RAL 9005
Conductor material	Bare Cu litz wires
Material wire insulation	PVC
Single wire, color	brown, white, blue, black
Overall twist	4 wires, twisted
Nominal voltage, cable	300 V
Test voltage	1500 V
Resistance to oil	good oil-resistance
Other resistance	UV resistant Silicone-free
Special properties	FDA compliant
Ambient temperature (operation)	-40 °C ... 80 °C (cable, fixed installation) -5 °C ... 90 °C (Cable, flexible installation)

## Environmental and real-life conditions

# SAC-4P-M12MS/ 1,5-511/M12FS FB - Sensor/actuator cable



1552641

<https://www.phoenixcontact.com/us/products/1552641>

## Ambient conditions

Degree of protection	IP65
	IP67
	IP68
	IP69K
Ambient temperature (operation) (male connector/female connector)	-25 °C ... 90 °C (Plug / socket)

## Standards and regulations

Standard designation	M12 connector
Standards/specifications	IEC 61076-2-101

# SAC-4P-M12MS/ 1,5-511/M12FS FB - Sensor/actuator cable



1552641

<https://www.phoenixcontact.com/us/products/1552641>

## Drawings

Dimensional drawing

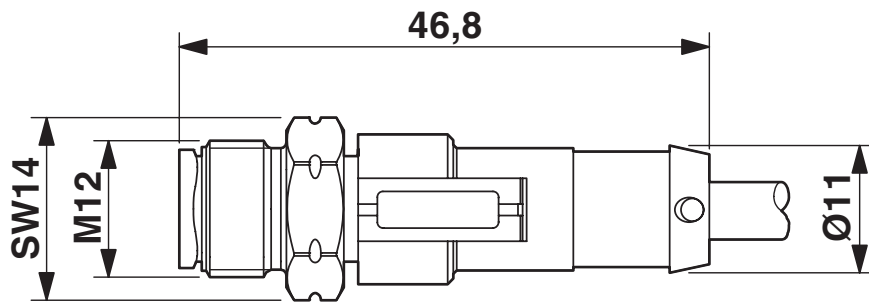

Plug, M12 x 1, straight, shielded

Dimensional drawing

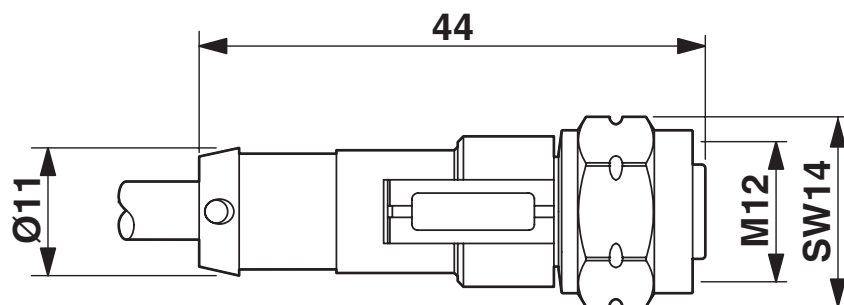

M12 x 1 socket, straight

# SAC-4P-M12MS/ 1,5-511/M12FS FB - Sensor/actuator cable

1552641

<https://www.phoenixcontact.com/us/products/1552641>

Schematic diagram



Pin assignment M12 plug, 4-pos., A-coded, view plug side

# SAC-4P-M12MS/ 1,5-511/M12FS FB - Sensor/actuator cable

1552641

<https://www.phoenixcontact.com/us/products/1552641>

Schematic diagram



Pin assignment M12 socket, 4-pos., A-coded, view female side

Circuit diagram



Contact assignment of the M12 plug and the M12 socket

# SAC-4P-M12MS/ 1,5-511/M12FS FB - Sensor/actuator cable



1552641

<https://www.phoenixcontact.com/us/products/1552641>

## Classifications

### ECLASS

ECLASS-13.0	27060311
ECLASS-15.0	27060311

### UNSPSC

UNSPSC 21.0	31251501
-------------	----------

# SAC-4P-M12MS/ 1,5-511/M12FS FB - Sensor/actuator cable



1552641

<https://www.phoenixcontact.com/us/products/1552641>

## Environmental product compliance

### China RoHS

Environment friendly use period (EFUP)	EFUP-50
	An article-related China RoHS declaration table can be found in the download area for the respective article under "Manufacturer declaration". For all articles with EFUP-E, no China RoHS declaration table issued and required.

### EU REACH SVHC

REACH candidate substance (CAS No.)	No substance above 0.1 wt%
-------------------------------------	----------------------------

Phoenix Contact 2026 © - all rights reserved  
<https://www.phoenixcontact.com>

Phoenix Contact USA  
586 Fulling Mill Road  
Middletown, PA 17057, United States  
(+717) 944-1300  
[info@phoenixcon.com](mailto:info@phoenixcon.com)