

IPD PL 3P2,5 F A5,0 PVC GY - Connecting cable



1526869

<https://www.phoenixcontact.com/us/products/1526869>

Please be informed that the data shown in this PDF document is generated from our online catalog. Please find the complete data in the user documentation. Our general terms of use for downloads are valid.



Connecting cable/ Push-lock connection, number of positions: 2+PE, Socket, 450 V, 16 A, PA, light gray, coding: P, 2.5 mm², cable length: 5 m, Socket straight, on free cable end

Your advantages

- Easy distribution of power, as components are plugged directly
- Simple, time-saving wiring in the field with Push-Lock connection
- Reliable installation in harsh environments with IP66, IP68, and IP69K throughout the entire system
- Secure, tool-free locking even in particularly difficult installation situations
- Fast commissioning with preassembled cable assemblies

Commercial data

Item number	1526869
Packing unit	1 pc
Minimum order quantity	1 pc
Sales key	BF51
Product key	AF6NAA
GTIN	4063151995362
Weight per piece (including packing)	817.3 g
Weight per piece (excluding packing)	817.3 g
Customs tariff number	85444290
Country of origin	PL

IPD PL 3P2,5 F A5,0 PVC GY - Connecting cable



1526869

<https://www.phoenixcontact.com/us/products/1526869>

Technical data

Product properties

Product type	Assembled installation cable
Product family	IPD
Number of positions	3
Connection profile	2+PE
Position marking	L, N, PE
Number of connections per position	1
Coding	P

Insulation characteristics

Overvoltage category	III
Degree of pollution	3

Electrical properties

Rated surge voltage (III/3)	6 kV
Rated current	16 A (in accordance with IEC 61984)
Rated voltage (III/3)	450 V (flexible installation)
	500 V (Fixed, protected installation)
Nominal voltage U_N	450 V AC/DC (flexible installation)
	500 V AC/DC (Fixed, protected installation)
Nominal current I_N	16 A (in accordance with IEC 61984)

Connection data

Connection technology

Connection method On the field side	Push-lock connection
Frequency of connections between conductors of the same cross section	max. 10

Dimensions

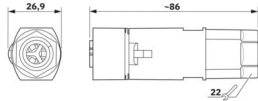
Dimensional drawing	
Width	26.5 mm
Height	26.9 mm
Length	85.9 mm

Material specifications

Color (Housing)	light gray (RAL 7035)
Material Housing	PA
Material Seal	NBR

IPD PL 3P2,5 F A5,0 PVC GY - Connecting cable



1526869

<https://www.phoenixcontact.com/us/products/1526869>

Contact material	Cu
Contact surface material	Ni/Ag/Sn

Cable/line

Cable length	5 m
Structure of individual litz in acc. with VDE 0295 / smallest wire diameter	Class 5 in accordance with IEC 60228
External cable diameter	9.6 mm
Position marking	L, N, PE
Single wire, color	brown L, blue N, green-yellow PE
Cable cross section	2.5 mm ²
Material wire insulation	PVC
Minimum bending radius, fixed installation	4 x D
Minimum bending radius, flexible installation	15 x D
Ambient temperature (operation)	-30 °C ... 80 °C (cable, fixed installation) -5 °C ... 70 °C (Cable, flexible installation)

Mechanical properties

Mechanical data

Insertion/withdrawal cycles	50 (IP66/IP68/IP69K)
	100 (IP66)

Environmental and real-life conditions

Ambient conditions

Degree of protection	IP66
	IP68 (2 m / 24 h)
	IP69K (Distance from the nozzle 150 mm)
	Touch-proof when not plugged in (IP2X)
Impact strength	IK07
Ambient temperature (operation) (Cable, flexible installation)	-5 °C ... 70 °C (Cable, flexible installation)
Ambient temperature (operation) (Cable, fixed installation)	-30 °C ... 80 °C (cable, fixed installation)
Ambient temperature (operation)	-30 °C ... 100 °C (Plug)
Temperature when conductor connected	-5 °C ... 50 °C
Resistance to UV radiation	no

IPD PL 3P2,5 F A5,0 PVC GY - Connecting cable



1526869

<https://www.phoenixcontact.com/us/products/1526869>

Drawings

Dimensional drawing

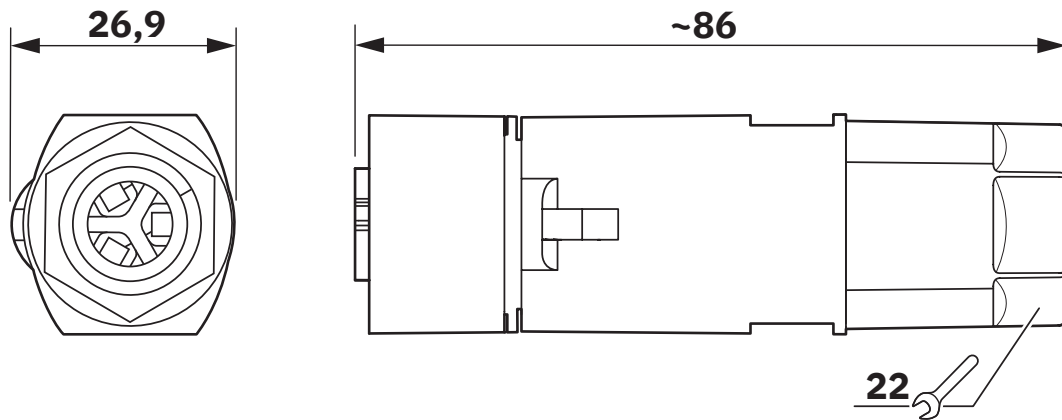

Diagram



Derating diagram for cable, flexible installation

IPD PL 3P2,5 F A5,0 PVC GY - Connecting cable



1526869

<https://www.phoenixcontact.com/us/products/1526869>

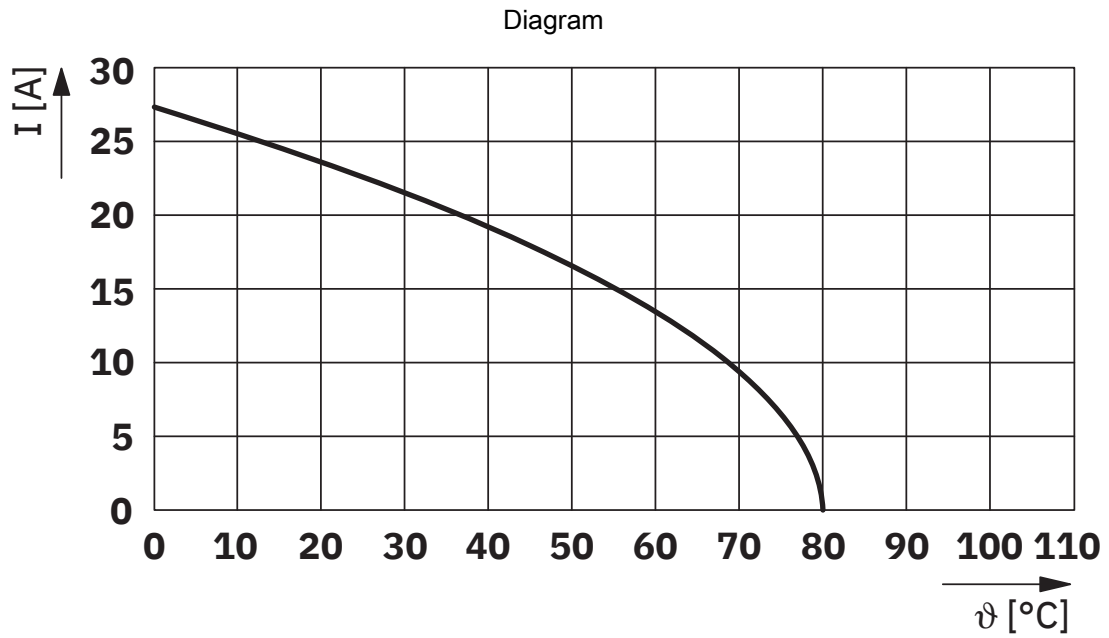

Derating diagram for cable, fixed installation

IPD PL 3P2,5 F A5,0 PVC GY - Connecting cable



1526869

<https://www.phoenixcontact.com/us/products/1526869>

Classifications

ECLASS

ECLASS-13.0	27440604
ECLASS-15.0	27440604

ETIM

ETIM 10.0	EC002587
-----------	----------

UNSPSC

UNSPSC 21.0	39121400
-------------	----------

IPD PL 3P2,5 F A5,0 PVC GY - Connecting cable



1526869

<https://www.phoenixcontact.com/us/products/1526869>

Environmental product compliance

EU RoHS

Fulfills EU RoHS substance requirements	Yes, No exemptions
---	--------------------

China RoHS

Environment friendly use period (EFUP)	EFUP-E
	No hazardous substances above the limits

EU REACH SVHC

REACH candidate substance (CAS No.)	No substance above 0.1 wt%
-------------------------------------	----------------------------

Phoenix Contact 2026 © - all rights reserved
<https://www.phoenixcontact.com>

Phoenix Contact USA
586 Fulling Mill Road
Middletown, PA 17057, United States
(+717) 944-1300
info@phoenixcon.com