

# HC-B 24-KML-H-O1M32 - Housing

1460323

<https://www.phoenixcontact.com/us/products/1460323>

Please be informed that the data shown in this PDF document is generated from our online catalog. Please find the complete data in the user documentation. Our general terms of use for downloads are valid.



HEAVYCON B24 coupling housing, with single locking latch, height: 80.5 mm, with 1 x M32 gland, straight cable outlet

## Commercial data

Item number	1460323
Packing unit	1 pc
Note	Made to order (non-returnable)
Sales key	BF55
Product key	AF7AAC
GTIN	4046356794763
Weight per piece (including packing)	324.5 g
Weight per piece (excluding packing)	324.5 g
Customs tariff number	85389099
Country of origin	DE

# HC-B 24-KML-H-O1M32 - Housing

1460323

<https://www.phoenixcontact.com/us/products/1460323>

## Technical data

### Notes

General	For contact inserts HC-B24, BB46, BBB64, D64, DD108, M
---------	--

### Product properties

Product type	Housing with locking latch
Housing type	Coupling housings
No. of cable outlets	1
Type of the screw connection	1x M32
Cable outlet	straight
Pg screw connection	none

### Dimensions

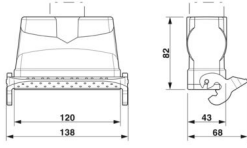
Dimensional drawing	
Width	43 mm
Height	82 mm
Length	120 mm

### Material specifications

Seal material	NBR
Housing material	Die-cast aluminum
Housing surface material	Powder-coated, gray
Locking latch material	Stainless steel, handle: PA

### Mechanical properties

#### Mechanical data

Type of the screw connection	1x M32
------------------------------	--------

### Mounting

Assembly note	For half and full screw connections
---------------	-------------------------------------

### Environmental and real-life conditions

#### Ambient conditions

Degree of protection	IP65
Ambient temperature (operation)	-40 °C ... 125 °C

# HC-B 24-KML-H-O1M32 - Housing

1460323

<https://www.phoenixcontact.com/us/products/1460323>



## Drawings

Dimensional drawing

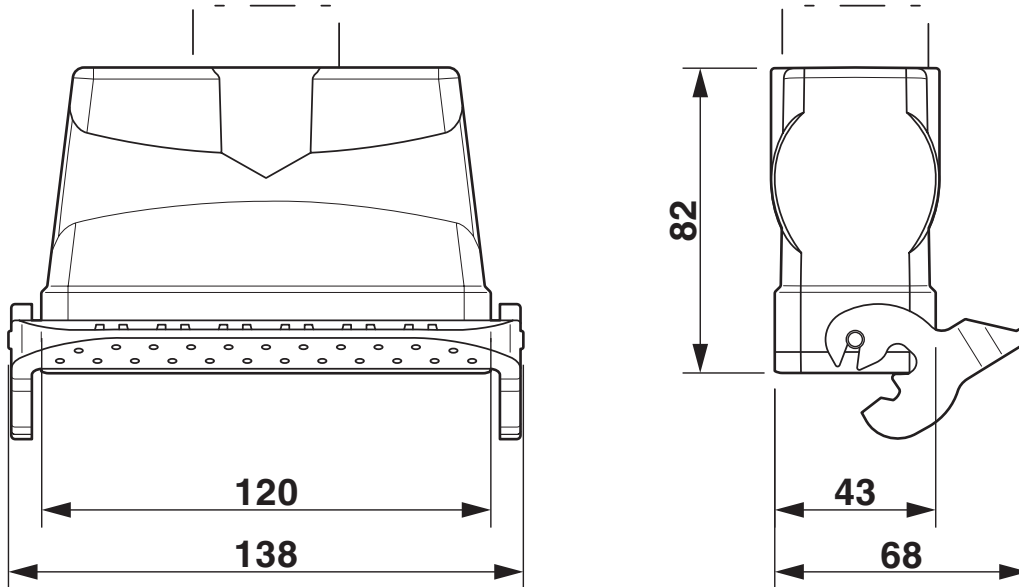

Dimensional drawing

# HC-B 24-KML-H-O1M32 - Housing



1460323

<https://www.phoenixcontact.com/us/products/1460323>

## Classifications

### ECLASS

ECLASS-13.0	27440202
ECLASS-15.0	27440202

# HC-B 24-KML-H-O1M32 - Housing



1460323

<https://www.phoenixcontact.com/us/products/1460323>

## Environmental product compliance

### EU RoHS

Fulfills EU RoHS substance requirements	Yes, No exemptions
---	--------------------

### China RoHS

Environment friendly use period (EFUP)	EFUP-E
	No hazardous substances above the limits

### EU REACH SVHC

REACH candidate substance (CAS No.)	No substance above 0.1 wt%
-------------------------------------	----------------------------

Phoenix Contact 2026 © - all rights reserved  
<https://www.phoenixcontact.com>

Phoenix Contact USA  
586 Fulling Mill Road  
Middletown, PA 17057, United States  
(+717) 944-1300  
[info@phoenixcon.com](mailto:info@phoenixcon.com)