

SAC-MS/0,1-116/2XA-1L-Z SCO - Double valve connector adapter



1458101

<https://www.phoenixcontact.com/us/products/1458101>

Please be informed that the data shown in this PDF document is generated from our online catalog. Please find the complete data in the user documentation. Our general terms of use for downloads are valid.



Double valve connector adapter, Universal, 4-position, PUR/PVC, black RAL 9005, Plug straight M12 SPEEDCON, coding: A, on Valve connector A, with 1 LED, Wiring: Z diode and Valve connector A, with 1 LED, Wiring: Z diode, valve connector spacing: 0.1 m

Your advantages

- Easy and safe: 100 % electrically tested plug-in components
- Efficient: control valves with two connections via a single connecting cable
- Convenient: increased machine availability thanks to quick and easy diagnostics

Commercial data

Item number	1458101
Packing unit	1 pc
Minimum order quantity	1 pc
Sales key	BF07
Product key	AF1DPA
GTIN	4046356638524
Weight per piece (including packing)	65.5 g
Weight per piece (excluding packing)	65.5 g
Customs tariff number	85444290
Country of origin	PL

SAC-MS/0,1-116/2XA-1L-Z SCO - Double valve connector adapter



1458101

<https://www.phoenixcontact.com/us/products/1458101>

Technical data

Product properties

Product type	Valve connector adapter
Sensor type	Universal
Number of positions	4
No. of cable outlets	1
Coding	A

Insulation characteristics

Overvoltage category	II
Degree of pollution	3

Connection data

Tightening torque	0.6 Nm (Valve connector)
-------------------	--------------------------

Electrical properties

Insulation resistance	$\geq 100 \text{ M}\Omega$
Nominal voltage U_N	24 V AC
	24 V DC
Nominal current I_N	4 A

Valve connector characteristics

Fixing screws	M3 x 29
Pulse power	40 W (at 100 μs square-wave pulse)
Terminal voltage	70 V (at 2 mA constant current)
Reverse voltage	50 V

Mechanical properties

Mechanical data

Insertion/withdrawal cycles	50 (Valve connector)
-----------------------------	----------------------

Material specifications

Flammability rating according to UL 94	HB
Seal material	TPU
Material housing valve plug	TPU
Contact material	CuSn
Contact surface material	Ni/Au
Contact carrier material	PA 6.6
Contact material	CuSn
Valve plug contact insert material	PA 6.6
Contact surface material	Sn
Material for screw connection	Zinc die-cast, nickel-plated

SAC-MS/0,1-116/2XA-1L-Z SCO - Double valve connector adapter



1458101

<https://www.phoenixcontact.com/us/products/1458101>

Signaling

Status display	1 LED
Status display present	yes

Connector

Connection 1

Type	Plug straight M12 SPEEDCON
Number of positions	4
Locking type	SPEEDCON
Coding type	A

Connection 2

Type	Valve connector A
Material	CuSn (Contact)
	Sn (Contact surface)
	PA 6.6 (Contact carrier)
	TPU (Housing)
Protective circuit	Z diode

Connection 3

Type	Valve connector A
Material	CuSn (Contact)
	Sn (Contact surface)
	PA 6.6 (Contact carrier)
	TPU (Housing)
Protective circuit	Z diode

Environmental and real-life conditions

Ambient conditions

Degree of protection	IP65
	IP67
Ambient temperature (operation) (Valve connector)	-25 °C ... 85 °C (Valve connector)

Standards and regulations

M12

Standard designation	M12 connector
Standards/specifications	IEC 61076-2-101

Valve connector

Standard designation	Valve connector
Standards/specifications	EN 175301-803

SAC-MS/0,1-116/2XA-1L-Z SCO - Double valve connector adapter

1458101

<https://www.phoenixcontact.com/us/products/1458101>

Drawings

Dimensional drawing

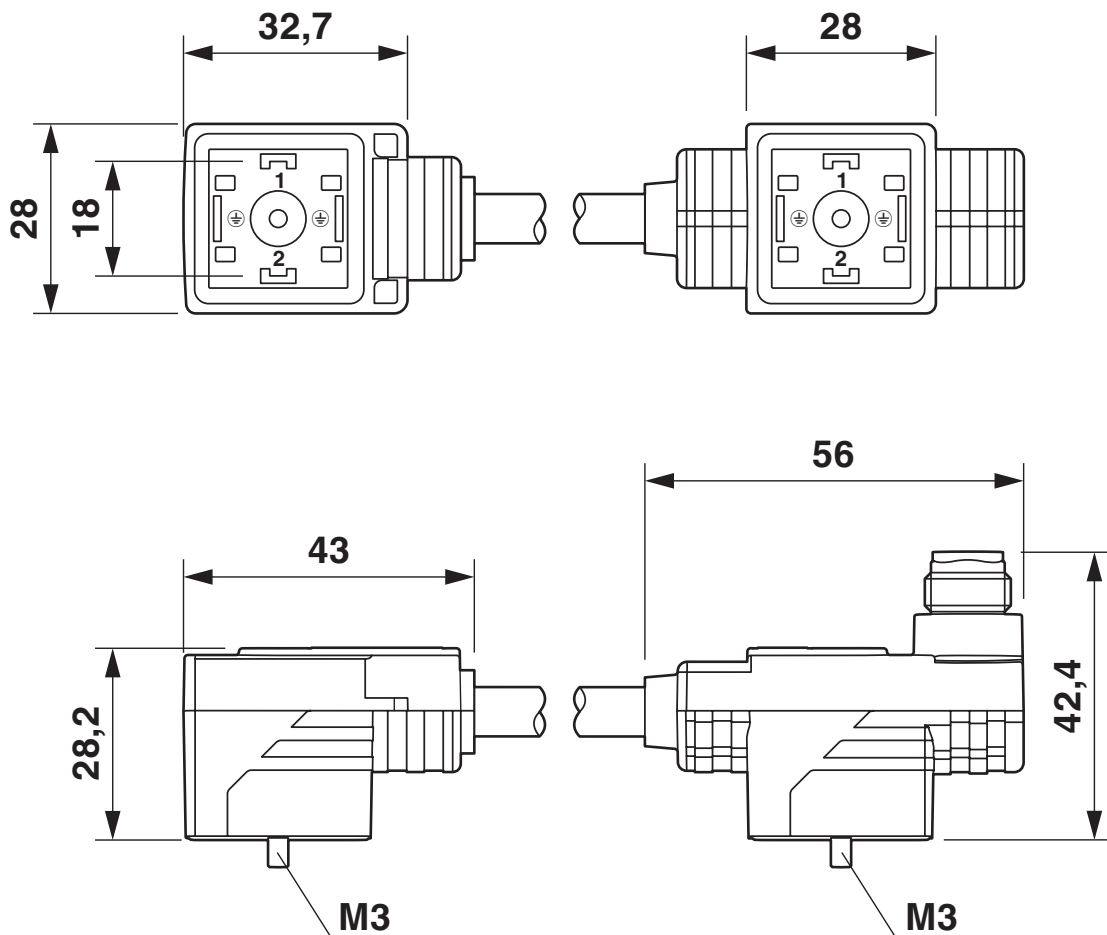

Double valve connector, 2x type A

SAC-MS/0,1-116/2XA-1L-Z SCO - Double valve connector adapter

1458101

<https://www.phoenixcontact.com/us/products/1458101>

Dimensional drawing

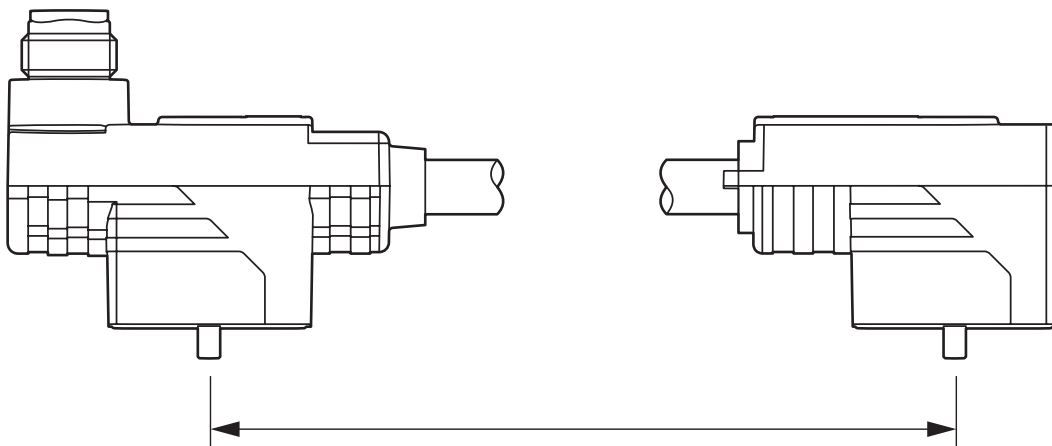

Valve connector spacing

Schematic diagram

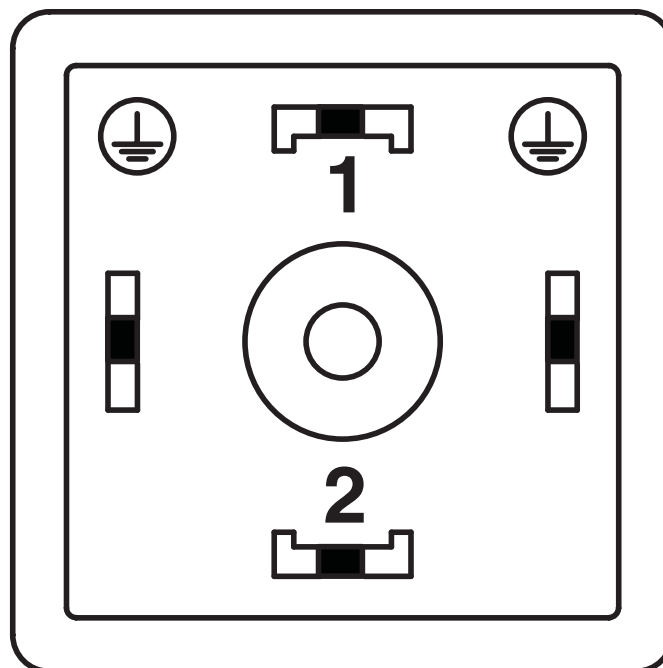

Valve connector pin assignment, type A

SAC-MS/0,1-116/2XA-1L-Z SCO - Double valve connector adapter

1458101

<https://www.phoenixcontact.com/us/products/1458101>

Circuit diagram

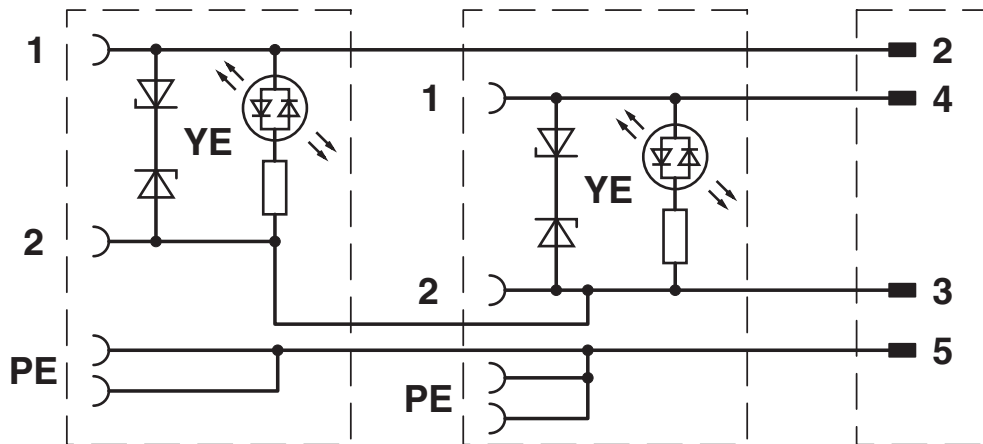

Contact assignment of the double-valve connector

SAC-MS/0,1-116/2XA-1L-Z SCO - Double valve connector adapter



1458101

<https://www.phoenixcontact.com/us/products/1458101>

Approvals

To download certificates, visit the product detail page: <https://www.phoenixcontact.com/us/products/1458101>

 CSAus Approval ID: 13631				
	Nominal voltage U_N	Nominal current I_N	Cross section AWG	Cross section mm^2
keine				
	24 V	4 A	-	-

SAC-MS/0,1-116/2XA-1L-Z SCO - Double valve connector adapter



1458101

<https://www.phoenixcontact.com/us/products/1458101>

Classifications

ECLASS

ECLASS-13.0	27060312
ECLASS-15.0	27060312

ETIM

ETIM 10.0	EC001855
-----------	----------

UNSPSC

UNSPSC 21.0	31251500
-------------	----------

SAC-MS/0,1-116/2XA-1L-Z SCO - Double valve connector adapter



1458101

<https://www.phoenixcontact.com/us/products/1458101>

Environmental product compliance

EU RoHS

Fulfills EU RoHS substance requirements	Yes
Exemption	7(c)-I

China RoHS

Environment friendly use period (EFUP)	EFUP-50
	An article-related China RoHS declaration table can be found in the download area for the respective article under "Manufacturer declaration". For all articles with EFUP-E, no China RoHS declaration table issued and required.

EU REACH SVHC

REACH candidate substance (CAS No.)	No substance above 0.1 wt%
-------------------------------------	----------------------------

EF3.1 Climate Change

CO2e kg	1.879 kg CO2e
---------	---------------

Phoenix Contact 2026 © - all rights reserved
<https://www.phoenixcontact.com>

Phoenix Contact USA
586 Fulling Mill Road
Middletown, PA 17057, United States
(+717) 944-1300
info@phoenixcon.com