

PROT-M12 FS VPE100 - Sealing cap

1439751

<https://www.phoenixcontact.com/us/products/1439751>

Please be informed that the data shown in this PDF document is generated from our online catalog. Please find the complete data in the user documentation. Our general terms of use for downloads are valid.



M12 sealing cap for unoccupied M12 plugs of the sensor/actuator cable, flush-type plugs and I/O devices in the field

Your advantages

- Reliable protection of unoccupied slots during transport and use in the field
- Protected against splash water and dust by the internal seal
- Good haptics due to ribbing on the cap
- Easy assembly without tools

Commercial data

Item number	1439751
Packing unit	100 pc
Minimum order quantity	100 pc
Note	Made to order (non-returnable)
Sales key	BF46
Product key	AF3ZAX
GTIN	4046356466813
Weight per piece (including packing)	1.51 g
Weight per piece (excluding packing)	0.85 g
Customs tariff number	39269097
Country of origin	DE

PROT-M12 FS VPE100 - Sealing cap



1439751

<https://www.phoenixcontact.com/us/products/1439751>

Technical data

Product properties

Thread type	M12
-------------	-----

Material specifications

Seal material	NBR
Material of grip body	PA 6

Environmental and real-life conditions

Ambient conditions

Degree of protection	IP67
Ambient temperature (operation) (male connector/female connector)	-40 °C ... 90 °C

PROT-M12 FS VPE100 - Sealing cap



1439751

<https://www.phoenixcontact.com/us/products/1439751>

Drawings

Dimensional drawing

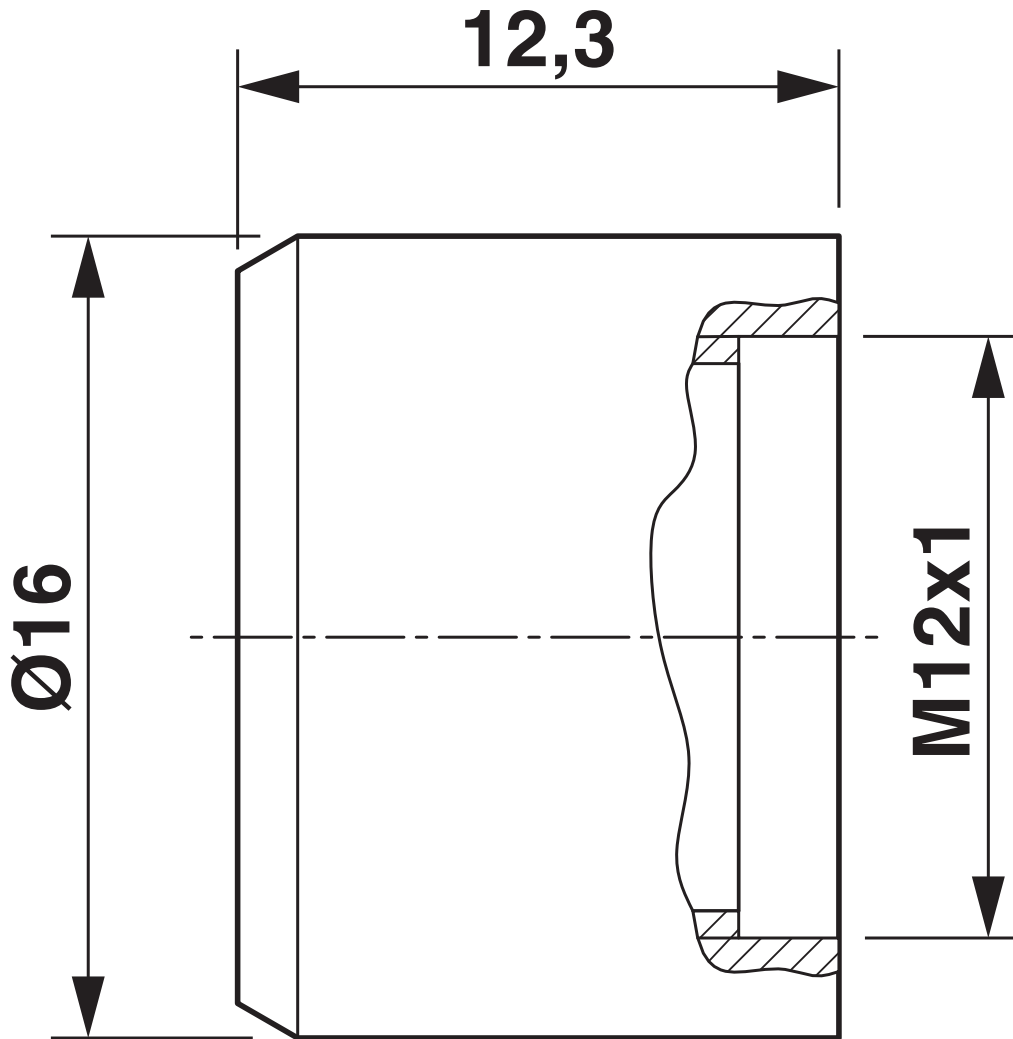

PROT-M12 FS VPE100 - Sealing cap



1439751

<https://www.phoenixcontact.com/us/products/1439751>

Classifications

ECLASS

ECLASS-13.0	23111190
ECLASS-15.0	27440208

ETIM

ETIM 10.0	EC002374
-----------	----------

UNSPSC

UNSPSC 21.0	26121600
-------------	----------

PROT-M12 FS VPE100 - Sealing cap



1439751

<https://www.phoenixcontact.com/us/products/1439751>

Environmental product compliance

EU RoHS

Fulfills EU RoHS substance requirements	Yes, No exemptions
---	--------------------

China RoHS

Environment friendly use period (EFUP)	EFUP-E
	No hazardous substances above the limits

EU REACH SVHC

REACH candidate substance (CAS No.)	No substance above 0.1 wt%
-------------------------------------	----------------------------

Phoenix Contact 2026 © - all rights reserved
<https://www.phoenixcontact.com>

Phoenix Contact USA
586 Fulling Mill Road
Middletown, PA 17057, United States
(+717) 944-1300
info@phoenixcon.com