

NBC-M12MSY/1,5-94H/M12MSY - Hybrid cable



1435347

<https://www.phoenixcontact.com/us/products/1435347>

Please be informed that the data shown in this PDF document is generated from our online catalog. Please find the complete data in the user documentation. Our general terms of use for downloads are valid.



Hybrid cable, Ethernet hybrid CAT5 (100 Mbps), 8-position, PUR halogen-free, black RAL 9005, shielded, Plug straight M12, on Plug straight M12, cable length: 1.5 m, Power with Ethernet (PWE)

Commercial data

Item number	1435347
Packing unit	1 pc
Minimum order quantity	50 pc
Note	Made to order (non-returnable)
Product key	AF1CMJ
GTIN	4063151809850
Weight per piece (including packing)	224.4 g
Weight per piece (excluding packing)	22.2 g
Country of origin	PL

1435347

<https://www.phoenixcontact.com/us/products/1435347>

Technical data

Product properties

Product type	Data cable preassembled
Application	Standard
Number of positions	8
No. of cable outlets	1
Shielded	yes
Coding	Y

Interfaces

Bus system	Ethernet
Signal type/category	Ethernet hybrid CAT5 (IEC 11801), 100 Mbps

Signaling

Status display	no
Status display present	no

Electrical properties

Nominal voltage U_N	48 V AC (Power and data)
	50 V DC (Power and data)
Nominal current I_N	6 A (Power)
	0.5 A (Data)
Transmission medium	Copper
Transmission speed	100 Mbps

Connector

Connection 1

Type	Plug straight M12
Material	CuZn
	Ni/Au
	PA 6 GF
	TPU, hardly inflammable, self-extinguishing
	Zinc die-cast, nickel-plated

Connection 2

Type	Plug straight M12
------	-------------------

Cable/line

Cable length	1.5 m
--------------	-------

Ethernet hybrid [94H]

NBC-M12MSY/1,5-94H/M12MSY - Hybrid cable

1435347

<https://www.phoenixcontact.com/us/products/1435347>

Dimensional drawing	
Cable weight	87 kg/km
UL AWM Style	20963 (80°C/30 V)
Number of positions	8
Shielded	yes
Cable type	Ethernet hybrid [94H]
Conductor structure	1x4xAWG26 + 1x4xAWG20
Conductor structure signal line	19x 0.10 mm
AWG signal line	26
Conductor structure, voltage supply	19x 0.20 mm
AWG power supply	20
Conductor cross-section	4x 0.15 mm ² (Data) 4x 0.6 mm ² (Power)
Wire diameter incl. insulation	1.05 mm (Data) 1.4 mm (Power)
External cable diameter	7.60 mm ±0.2 mm
Outer sheath, material	PUR
External sheath, color	black RAL 9005
Conductor material	Bare Cu litz wires
Material wire insulation	PP (Data) PP (Power)
Single wire, color	white/orange, orange, white/green, green, white, blue, brown, black
Overall twist	1 star quad and 4 wires with 2 fillers
Optical shield covering	85 %
Insulation resistance	≥ 5 GΩ*km
Loop resistance	≤ 280.00 Ω/km (Data) ≤ 34.60 Ω/km (Power)
Wave impedance	100 Ω ±15 Ω (4 MHz ... 100 MHz)
Working capacitance	nom. 50 nF (per kilometer)
Differential impedance	100 Ω ±5 % (at 100 MHz)
Nominal voltage, cable	≤ 50 V (Peak value, not for high-power applications)
Test voltage Core/Core	1500 V (50 Hz, 1 min.)
Test voltage Core/Shield	1500.00 V (50 Hz, 1 min.)
Minimum bending radius, fixed installation	5 x D
Minimum bending radius, flexible installation	10 x D
Smallest bending radius, fixed installation	38 mm

NBC-M12MSY/1,5-94H/M12MSY - Hybrid cable



1435347

<https://www.phoenixcontact.com/us/products/1435347>

Smallest bending radius, movable installation	76 mm
Dynamic load capacity (bending)	Max. bending cycles: 2000000, Traversing path: 4.5 m, Traversing rate: 3 m/s, Acceleration: 4 m/s ²
Tensile strength	70 N (in accordance with DIN EN 50565-1 for flexible installation) 240 N (in accordance with DIN EN 50565-1 for fixed installation)
Near end crosstalk attenuation (NEXT)	56.3 dB (at 4 MHz) 50.3 dB (at 10 MHz) 47.2 dB (at 16 MHz) 45.8 dB (at 20 MHz) 42.9 dB (at 31.25 MHz) 38.4 dB (at 62.5 MHz) 35.3 dB (at 100 MHz)
Shield attenuation	6 dB (at 4 MHz) 9.5 dB (at 10 MHz) 12.1 dB (at 16 MHz) 13.5 dB (at 20 MHz) 17.1 dB (at 31.25 MHz) 24.8 dB (at 62.5 MHz) 32 dB (at 100 MHz) ≥ 80.00 dB (30 MHz ... 125 MHz)
Halogen-free	according to IEC 60754 in accordance with DIN VDE 0472 part 815
Flame resistance	in acc. with UL 1581, section 1061 in acc. with UL 1581, section 1061
Resistance to oil	according to IEC 60811-2-1 according to VDE 0282 Part 10
Other resistance	Low adhesion
Special properties	Free of substances which would hinder coating with paint or varnish Silicone-free
Ambient temperature (operation)	-40 °C ... 90 °C (cable, fixed installation) -30 °C ... 70 °C (Cable, flexible installation)

Environmental and real-life conditions

Ambient conditions

Degree of protection	IP65 IP67
Ambient temperature (operation) (male connector/female connector)	-25 °C ... 90 °C (M12 connector)

Standards and regulations

Standard designation	M12 connector
Standards/specifications	IEC 61076-2-113

Drawings

Dimensional drawing

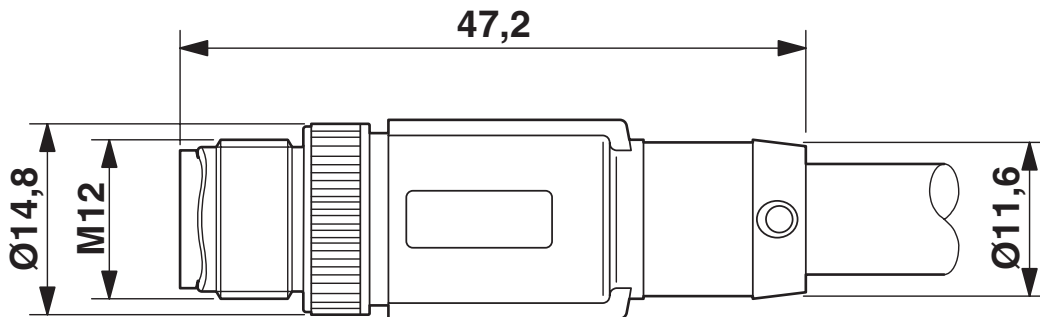

Plug, M12 x 1, straight, shielded

Schematic diagram

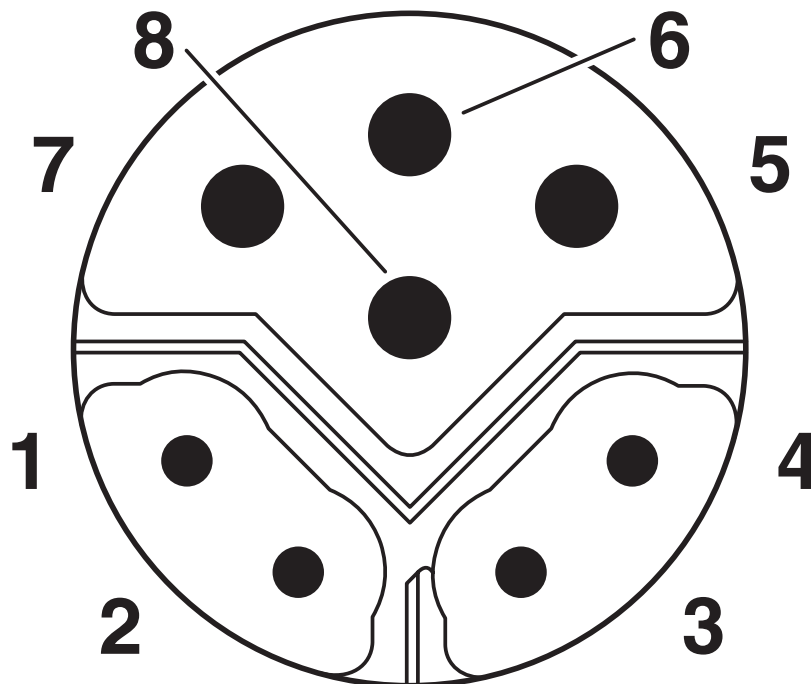

M12 hybrid plug pin assignment, 8-pos., Y-coded, pin side view

NBC-M12MSY/1,5-94H/M12MSY - Hybrid cable



1435347

<https://www.phoenixcontact.com/us/products/1435347>

Circuit diagram

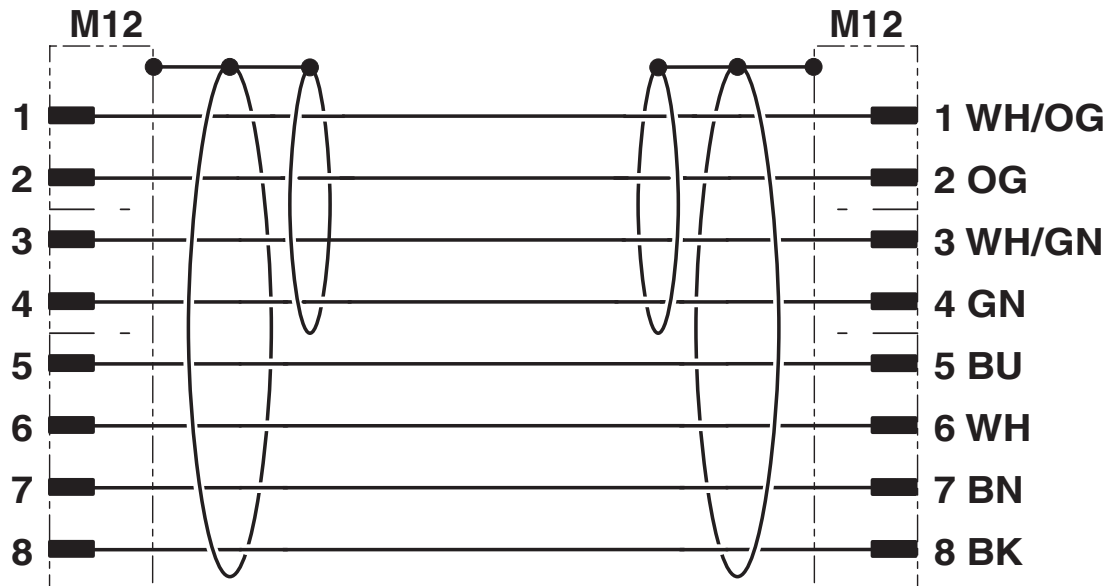

Contact assignment of the M12 plugs

NBC-M12MSY/1,5-94H/M12MSY - Hybrid cable



1435347

<https://www.phoenixcontact.com/us/products/1435347>

Approvals

To download certificates, visit the product detail page: <https://www.phoenixcontact.com/us/products/1435347>

 UL Listed Approval ID: FILE E 335024				
	Nominal voltage U_N	Nominal current I_N	Cross section AWG	Cross section mm^2
keine				
	56.5 V	0.175 A	-	-

 cUL Listed Approval ID: FILE E 335024				
	Nominal voltage U_N	Nominal current I_N	Cross section AWG	Cross section mm^2
keine				
	56.5 V	0.175 A	-	-

 cUL Listed Approval ID: E221474				
	Nominal voltage U_N	Nominal current I_N	Cross section AWG	Cross section mm^2
keine				
Power	30 V	6 A	-	-
Data	42 V	0.5 A	-	-

 UL Listed Approval ID: E221474				
	Nominal voltage U_N	Nominal current I_N	Cross section AWG	Cross section mm^2
keine				
Power	30 V	6 A	-	-
Data	42 V	0.5 A	-	-

NBC-M12MSY/1,5-94H/M12MSY - Hybrid cable



1435347

<https://www.phoenixcontact.com/us/products/1435347>

Classifications

ECLASS

ECLASS-13.0	27060307
ECLASS-15.0	27060307

UNSPSC

UNSPSC 21.0	26121600
-------------	----------

NBC-M12MSY/1,5-94H/M12MSY - Hybrid cable



1435347

<https://www.phoenixcontact.com/us/products/1435347>

Environmental product compliance

EU RoHS

Fulfills EU RoHS substance requirements	Yes, No exemptions
---	--------------------

China RoHS

Environment friendly use period (EFUP)	EFUP-E
	No hazardous substances above the limits

EU REACH SVHC

REACH candidate substance (CAS No.)	No substance above 0.1 wt%
-------------------------------------	----------------------------

Phoenix Contact 2026 © - all rights reserved
<https://www.phoenixcontact.com>

Phoenix Contact USA
586 Fulling Mill Road
Middletown, PA 17057, United States
(+717) 944-1300
info@phoenixcon.com