

SAC-4P-MINMR/ 2,0-961/MINFSVAL - Bus system cable



1434293

<https://www.phoenixcontact.com/us/products/1434293>

Please be informed that the data shown in this PDF document is generated from our online catalog. Please find the complete data in the user documentation. Our general terms of use for downloads are valid.

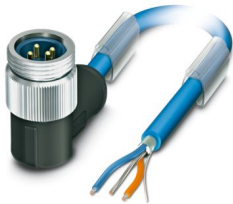

Bus system cable, FOUNDATION Fieldbus (31.25 kbps), 3-position, PVC, blue RAL 5015, shielded, Plug angled 7/8"-16UNF, coding: A, on Socket straight 7/8"-16UNF, coding: A, cable length: 2 m



Commercial data

Item number	1434293
Packing unit	1 pc
Minimum order quantity	1 pc
Note	Made to order (non-returnable)
Product key	AF1FCG
GTIN	4046356455947
Weight per piece (including packing)	222.22 g
Weight per piece (excluding packing)	222.22 g
Country of origin	DE

SAC-4P-MINMR/ 2,0-961/MINFSVAL - Bus system cable



1434293

<https://www.phoenixcontact.com/us/products/1434293>

Technical data

Product properties

Product type	Data cable preassembled
Application	Process technology
Number of positions	3
No. of cable outlets	1
Coding	A

Insulation characteristics

Degree of pollution	2
---------------------	---

Interfaces

Bus system	FOUNDATION Fieldbus
Signal type/category	FOUNDATION Fieldbus, 31.25 kbps

Signaling

Status display	no
----------------	----

Electrical properties

Insulation resistance	$\geq 10 \text{ M}\Omega$
Nominal voltage U_N	300 V
Nominal current I_N	5.2 A
Transmission medium	Copper
Transmission speed	31.25 kbps

Material specifications

Seal material	TPU
Material of grip body	TPU
Contact material	CuZn
Contact surface material	Au
Contact carrier material	PA 6.6
Material for screw connection	Stainless steel

Connection data

Connection assignment

Contact Color (signal designation) Contact (optional)	1 (Plug) BU (DATA-) 1 (Socket)
	2 (Plug) OG (DATA+) 2 (Socket)
	3 (Plug) SR (shield) 3 (Socket)

Connector

Connection 1

Type	Plug angled 7/8"-16UNF
------	------------------------

SAC-4P-MINMR/ 2,0-961/MINFSVAL - Bus system cable



1434293

<https://www.phoenixcontact.com/us/products/1434293>

Number of positions	3
Coding type	A (Standard)

Connection 2

Type	Socket straight 7/8"-16UNF
Number of positions	3
Coding type	A (Standard)

Cable/line

Cable length	2 m
--------------	-----

Fieldbus FOUNDATION/PROFIBUS PA, blue [961]

Dimensional drawing	
Cable weight	56.552 kg/km
Number of positions	2
Shielded	yes
Cable type	Fieldbus FOUNDATION/PROFIBUS PA, blue [961]
Conductor structure	2xAWG18/7 + 1xAWG20/7
Signal speed	0.66 c
Conductor structure signal line	7x 0.40 mm
AWG signal line	18
Conductor cross-section	2x 0.75 mm ² (Signal line) 1x 0.5 mm ² (Drain wire)
Wire diameter incl. insulation	2.24 mm ±0.05 mm
External cable diameter	7.50 mm ±0.25 mm
Outer sheath, material	PVC
External sheath, color	blue RAL 5015
Conductor material	Tin-plated Cu litz wires
Material wire insulation	PO (Signal line)
Single wire, color	blue, orange
Thickness, insulation	0.50 mm
Thickness, outer sheath	1.00 mm
Twisted pairs	2 cores to the pair
Overall twist	One pair with one drain wire and fillers for core
Optical shield covering	100 %
Max. conductor resistance	≤ 19.35 Ω/km (Signal line) 26 Ω/km (shield)
Cable capacity	147 pF/m (at 1 kHz, core/shield)

SAC-4P-MINMR/ 2,0-961/MINFSVAL - Bus system cable



1434293

<https://www.phoenixcontact.com/us/products/1434293>

	≤ 3.94 pF/m (capacitance unbalance)
Working capacitance	78 nF (at 1 kHz)
Cable impedance	100 Ω ±20 % (At 31.25 kHz)
Nominal voltage, cable	300 V
Smallest bending radius, fixed installation	75 mm
Tensile strength	260 N
Shield attenuation	3.00 dB/km (at 39 kHz)
Flame resistance	UL 1685 (CSA FT 4)
	UL 1685 (vertical tray)
	UL 1666 (riser)
Special properties	UL standards PLTC-ER and ITC
Ambient temperature (operation)	-40 °C ... 105 °C (cable, fixed installation)

Environmental and real-life conditions

Ambient conditions

Degree of protection	IP67
Enclosure rating (NEMA)	1 (NEMA)
	3 (NEMA)
	4 (NEMA)
	6P (NEMA)
Ambient temperature (operation) (male connector/female connector)	-40 °C ... 105 °C (Plug / socket)

SAC-4P-MINMR/ 2,0-961/MINFSVAL - Bus system cable



1434293

<https://www.phoenixcontact.com/us/products/1434293>

Drawings

Dimensional drawing

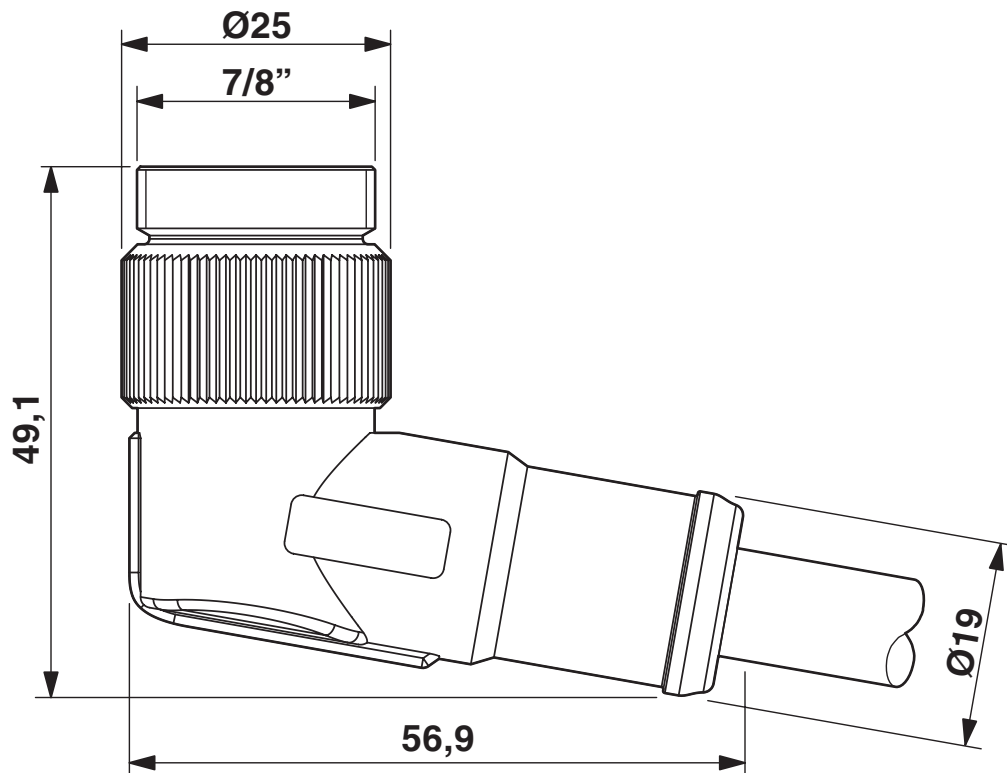

7/8"-16UNF plug, angled

SAC-4P-MINMR/ 2,0-961/MINFSVAL - Bus system cable



1434293

<https://www.phoenixcontact.com/us/products/1434293>

Schematic diagram



Pin assignment, plug, 7/8"-16UNF, 4-pos., view of male side

Schematic diagram

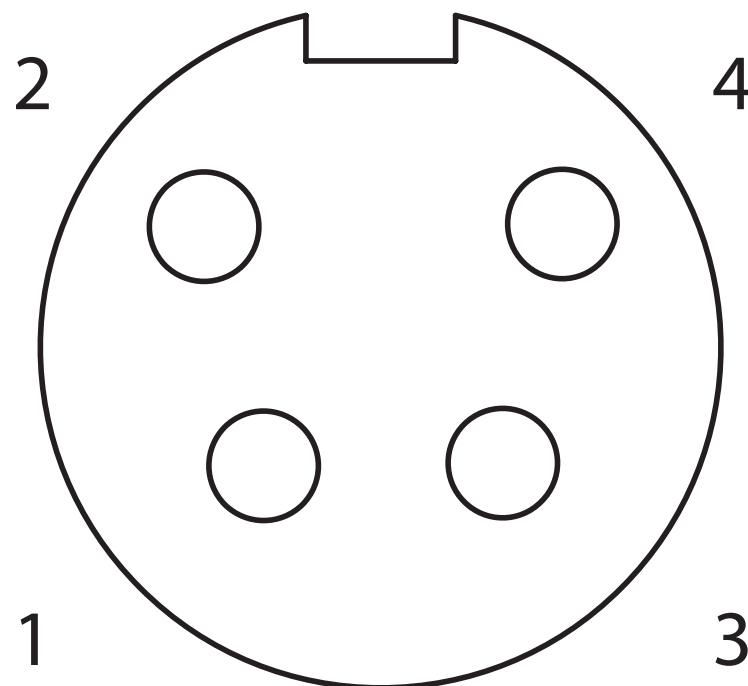

Pin assignment, socket, 7/8"-16UNF, 4-pos., view of female side

SAC-4P-MINMR/ 2,0-961/MINFSVAL - Bus system cable



1434293

<https://www.phoenixcontact.com/us/products/1434293>

Circuit diagram

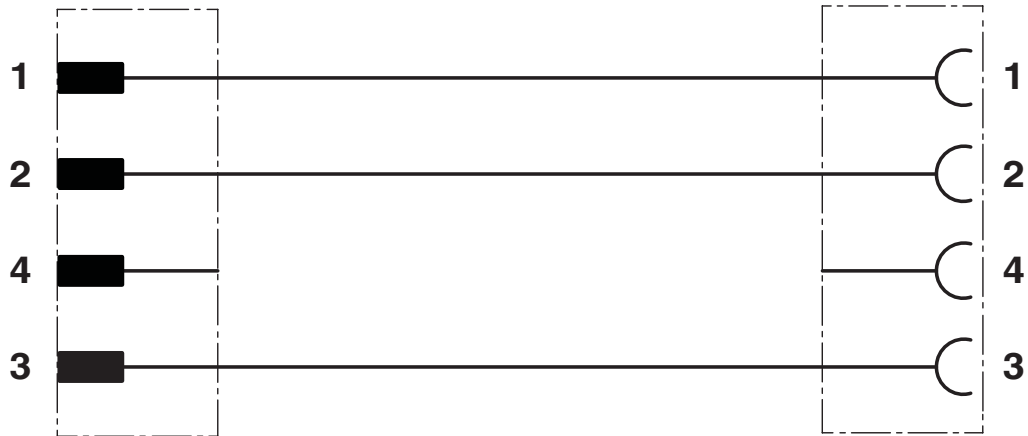

Contact assignment of the 7/8" connector and the 7/8" socket

SAC-4P-MINMR/ 2,0-961/MINFSVAL - Bus system cable



1434293

<https://www.phoenixcontact.com/us/products/1434293>

Classifications

ECLASS

ECLASS-13.0	27060307
ECLASS-15.0	27060307

SAC-4P-MINMR/ 2,0-961/MINFSVAL - Bus system cable



1434293

<https://www.phoenixcontact.com/us/products/1434293>

Environmental product compliance

China RoHS

Environment friendly use period (EFUP)	EFUP-50
	An article-related China RoHS declaration table can be found in the download area for the respective article under "Manufacturer declaration". For all articles with EFUP-E, no China RoHS declaration table issued and required.

EU REACH SVHC

REACH candidate substance (CAS No.)	No substance above 0.1 wt%
-------------------------------------	----------------------------

Phoenix Contact 2026 © - all rights reserved
<https://www.phoenixcontact.com>

Phoenix Contact USA
586 Fulling Mill Road
Middletown, PA 17057, United States
(+717) 944-1300
info@phoenixcon.com