

# SAC-4P-M12MSL/0,3-105/FSL - Power cable



1425041

<https://www.phoenixcontact.com/us/products/1425041>

Please be informed that the data shown in this PDF document is generated from our online catalog. Please find the complete data in the user documentation. Our general terms of use for downloads are valid.



Power cable, 4-position, PUR halogen-free, black-gray RAL 7021, Plug straight M12, coding: L, on Socket straight M12, coding: L, cable length: 0.3 m, For direct current up to 12 A/63 V

## Your advantages

- Easy and safe: 100 % electrically tested plug-in components
- Protection against mismatching, thanks to special L-coding
- Our standard: robust halogen-free PUR cable

## Commercial data

Item number	1425041
Packing unit	1 pc
Minimum order quantity	1 pc
Sales key	BF05
Product key	AF1CCR
GTIN	4055626383798
Weight per piece (including packing)	94.63 g
Weight per piece (excluding packing)	94.63 g
Customs tariff number	85444290
Country of origin	US

1425041

<https://www.phoenixcontact.com/us/products/1425041>

## Technical data

### Product properties

Product type	Power cable
Application	Energy supply
Number of positions	4
No. of cable outlets	1
Shielded	no
Coding	L

### Insulation characteristics

Overvoltage category	III
Degree of pollution	3

### Material specifications

Flammability rating according to UL 94	V0
Material of grip body	PP
Contact material	CuZn
Contact surface material	Ni/Au
Contact carrier material	PA
Material for screw connection	Zinc die-cast, nickel-plated

### Electrical properties

Insulation resistance	$\geq 100 \text{ M}\Omega$
Nominal voltage $U_N$	63 V DC
Nominal current $I_N$	12 A

### Mechanical properties

#### Mechanical data

Insertion/withdrawal cycles	$\geq 100$
-----------------------------	------------

### Connector

#### Connection 1

Type	Plug straight M12
Coding type	L (Power)

#### Connection 2

Type	Socket straight M12
Coding type	L (Power)

### Cable/line

Cable length	0.3 m
--------------	-------

PUR halogen-free black [PUR]

# SAC-4P-M12MSL/0,3-105/FSL - Power cable



1425041

<https://www.phoenixcontact.com/us/products/1425041>

Dimensional drawing	
Cable weight	83 kg/km
UL AWM Style	20549 / 10493 (80°C/300 V)
Number of positions	4
Shielded	no
Cable type	PUR halogen-free black [PUR]
Conductor structure, voltage supply	44x 0.20 mm
AWG power supply	16
Conductor cross-section	4x 1.5 mm <sup>2</sup>
Wire diameter incl. insulation	2.2 mm ±0.05 mm
External cable diameter	6.75 mm ±0.2 mm
Outer sheath, material	PUR
External sheath, color	black-gray RAL 7021
Conductor material	Bare Cu litz wires
Material wire insulation	PP
Single wire, color	brown, white, blue, black
Thickness, insulation	≥ 0.26 mm
Thickness, outer sheath	approx. 0.70 mm
Overall twist	4 wires, twisted
Max. conductor resistance	≤ 14.1 Ω/km (at 20 °C)
Insulation resistance	≥ 1 GΩ*km (at 20 °C)
Nominal voltage, cable	≤ 300 V AC
Test voltage	≥ 3000 V AC (Spark test)
Minimum bending radius, fixed installation	5 x D
Minimum bending radius, flexible installation	10 x D
Smallest bending radius, fixed installation	34 mm
Smallest bending radius, movable installation	68 mm
Dynamic load capacity (bending)	Max. bending cycles: 5000000, Bending radius: 10 x D, Traversing path: 10 m, Traversing rate: 3 m/s, Acceleration: 10 m/s <sup>2</sup>
Dynamic load capacity (torsion)	Torsion: ±180 °/m, Torsion cycles: 500000, Torsional frequency: 35 cycles/min.
Halogen-free	in accordance with DIN VDE 0472 part 815 in accordance with DIN EN 50267-2-1
Flame resistance	According to UL 758/1581 (Cable Flame) in accordance with UL 758/1581 FT2 according to DIN EN 60332-2-2

# SAC-4P-M12MSL/0,3-105/FSL - Power cable



1425041

<https://www.phoenixcontact.com/us/products/1425041>

Resistance to oil	according to DIN EN 60811-404, 168 h at 100 °C
	according to UL 758, 168 h at 60 °C
Other resistance	Hydrolysis and microbe resistant as per VDE 0282 section 10
	Low adhesion
	abrasion-resistant
	Resistant to salt water
Special properties	Flexible cable conduit capable
Ambient temperature (operation)	-50 °C ... 85 °C (cable, fixed installation)
	-30 °C ... 85 °C (Cable, flexible installation)

## Environmental and real-life conditions

### Ambient conditions

Degree of protection	IP65
	IP67
Ambient temperature (operation) (male connector/female connector)	-25 °C ... 85 °C (Plug / socket)

## Standards and regulations

Standard designation	M12 connector
Standards/specifications	IEC 61076-2-111

# SAC-4P-M12MSL/0,3-105/FSL - Power cable



1425041

<https://www.phoenixcontact.com/us/products/1425041>

## Drawings



Plug, M12 x 1, straight, shielded



M12 x 1 socket, straight

1425041

<https://www.phoenixcontact.com/us/products/1425041>

Schematic diagram

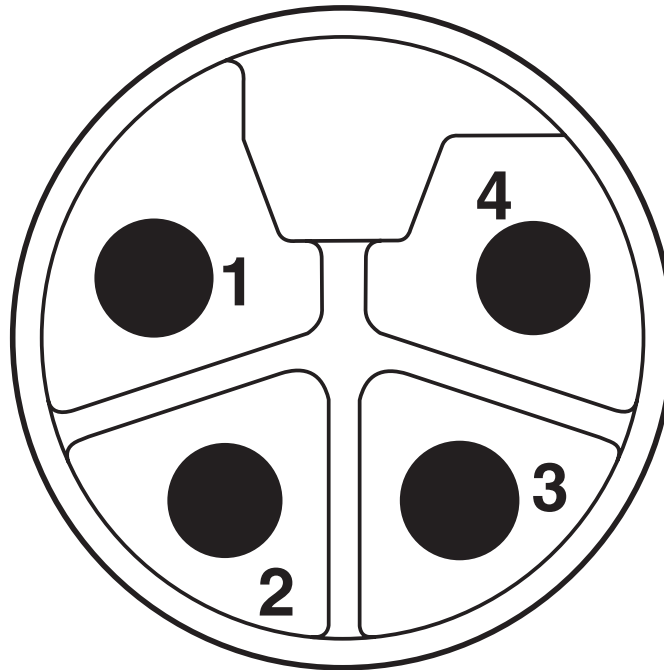

Pin assignment M12 male connector, 4-pos.

Schematic diagram

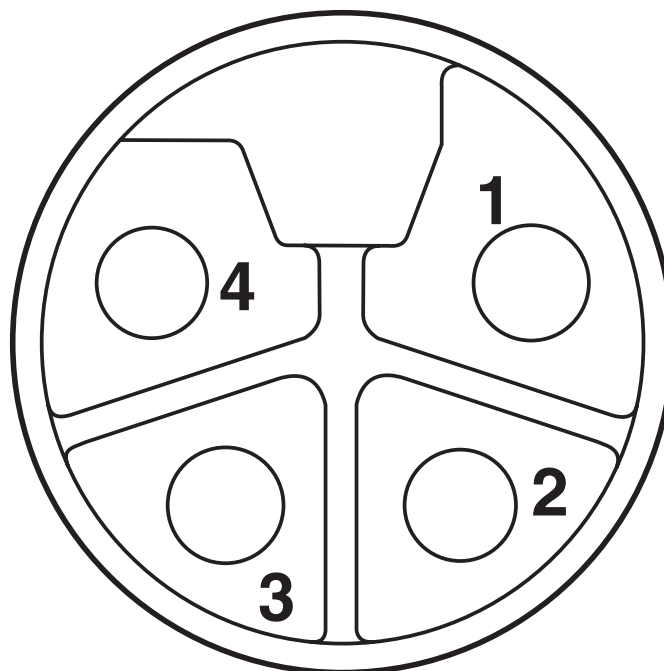

Pin assignment of M12 socket, 4-pos.



Base curve

Circuit diagram



Contact assignment of M12 connector/socket

# SAC-4P-M12MSL/0,3-105/FSL - Power cable



1425041

<https://www.phoenixcontact.com/us/products/1425041>

## Approvals

To download certificates, visit the product detail page: <https://www.phoenixcontact.com/us/products/1425041>



**UL Listed**

Approval ID: E468743



**cUL Listed**

Approval ID: E468743



**EAC-RoHS**

Approval ID: RU D-DE.HB35.B.00387

# SAC-4P-M12MSL/0,3-105/FSL - Power cable



1425041

<https://www.phoenixcontact.com/us/products/1425041>

## Classifications

### ECLASS

ECLASS-13.0	27060327
ECLASS-15.0	27060327

### ETIM

ETIM 10.0	EC001855
-----------	----------

### UNSPSC

UNSPSC 21.0	26121600
-------------	----------

# SAC-4P-M12MSL/0,3-105/FSL - Power cable



1425041

<https://www.phoenixcontact.com/us/products/1425041>

## Environmental product compliance

### EU RoHS

Fulfills EU RoHS substance requirements	Yes, No exemptions
---	--------------------

### China RoHS

Environment friendly use period (EFUP)	EFUP-E
	No hazardous substances above the limits

### EU REACH SVHC

REACH candidate substance (CAS No.)	No substance above 0.1 wt%
-------------------------------------	----------------------------

### EF3.1 Climate Change

CO2e kg	2.603 kg CO2e
---------	---------------

Phoenix Contact 2026 © - all rights reserved  
<https://www.phoenixcontact.com>

Phoenix Contact USA  
586 Fulling Mill Road  
Middletown, PA 17057, United States  
(+717) 944-1300  
[info@phoenixcon.com](mailto:info@phoenixcon.com)