

# A-INL-PG16-P-LG - Counter nut



1424552

<https://www.phoenixcontact.com/us/products/1424552>

Please be informed that the data shown in this PDF document is generated from our online catalog. Please find the complete data in the user documentation. Our general terms of use for downloads are valid.

Counter nut, connecting thread: Pg16, color: light gray



## Commercial data

Item number	1424552
Packing unit	5 pc
Minimum order quantity	1 pc
Sales key	BF68
Product key	AF7DZX
GTIN	4055626374567
Weight per piece (including packing)	3.96 g
Weight per piece (excluding packing)	3.2 g
Customs tariff number	39269097
Country of origin	TR

# A-INL-PG16-P-LG - Counter nut

1424552

<https://www.phoenixcontact.com/us/products/1424552>

## Technical data

### Product properties

Product type	Flat nut
--------------	----------

### Dimensions

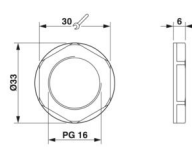
Dimensional drawing	
Length	6 mm
Diameter	22.5 mm
Connecting thread diameter	22.5 mm
Wrench size, counter nut	30 mm
Hexagon angular dimension	33 mm
Thread type connection side	Pg16

### Material specifications

Material	PA 6.6 GF
Flammability rating according to UL 94	V2

### Cable/line

Halogen-free	yes
--------------	-----

### Environmental and real-life conditions

#### Ambient conditions

Ambient temperature (operation)	-40 °C ... 100 °C
---------------------------------	-------------------

# A-INL-PG16-P-LG - Counter nut

1424552

<https://www.phoenixcontact.com/us/products/1424552>



## Drawings

Dimensional drawing

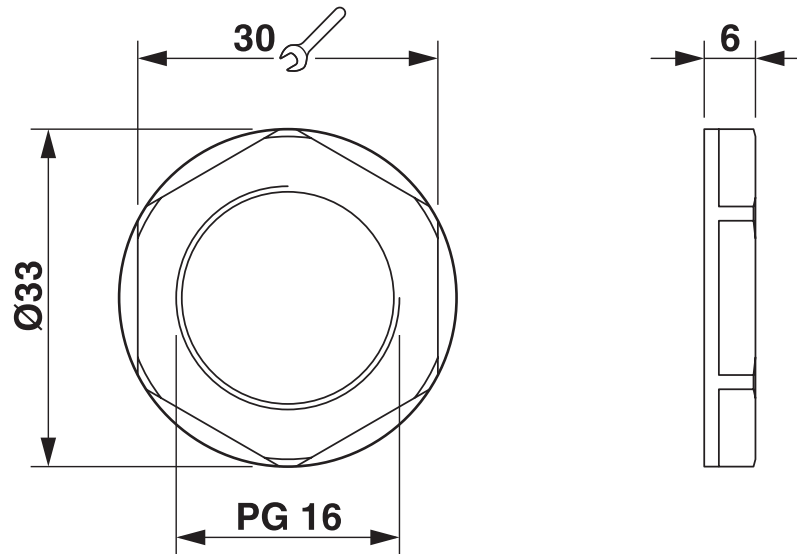

# A-INL-PG16-P-LG - Counter nut



1424552

<https://www.phoenixcontact.com/us/products/1424552>

## Classifications

### ECLASS

ECLASS-13.0	27140807
ECLASS-15.0	27140807

### ETIM

ETIM 10.0	EC003608
-----------	----------

### UNSPSC

UNSPSC 21.0	31161700
-------------	----------

# A-INL-PG16-P-LG - Counter nut



1424552

<https://www.phoenixcontact.com/us/products/1424552>

## Environmental product compliance

### EU RoHS

Fulfills EU RoHS substance requirements	Yes, No exemptions
---	--------------------

### China RoHS

Environment friendly use period (EFUP)	EFUP-E
	No hazardous substances above the limits

### EU REACH SVHC

REACH candidate substance (CAS No.)	No substance above 0.1 wt%
-------------------------------------	----------------------------

Phoenix Contact 2026 © - all rights reserved  
<https://www.phoenixcontact.com>

Phoenix Contact USA  
586 Fulling Mill Road  
Middletown, PA 17057, United States  
(+717) 944-1300  
[info@phoenixcon.com](mailto:info@phoenixcon.com)