

HC-M-08-PT-M - Contact insert module



1424227

<https://www.phoenixcontact.com/us/products/1424227>

Please be informed that the data shown in this PDF document is generated from our online catalog. Please find the complete data in the user documentation. Our general terms of use for downloads are valid.



Contact insert module, number of positions: 8, power contacts: 8, control contacts: 0, Pin, Push-in connection, 400 V, 16 A, 0.5 mm² ... 2.5 mm², application: Power

Your advantages

- Easy installation without tools, even when mounted, with push-in connection technology
- Shortest installation time compared to other connection technologies
- Quick and effortless wiring, in particular when space is tight
- Automatic cabling with robots possible
- Safe wiring and operation with color-coded actuators
- Shock and vibration-resistant in accordance with DIN EN 61373

Commercial data

Item number	1424227
Packing unit	1 pc
Minimum order quantity	1 pc
Sales key	BF62
Product key	AF7ACE
GTIN	4055626369587
Weight per piece (including packing)	22.7 g
Weight per piece (excluding packing)	20.66 g
Customs tariff number	85366990
Country of origin	CN

HC-M-08-PT-M - Contact insert module



1424227

<https://www.phoenixcontact.com/us/products/1424227>

Technical data

Notes

General	for flexible conductors with or without ferrules
General	Connectors may be operated only when there is no load/voltage.
General	Flexible conductors may be used without ferrules as long as they comply with IEC 60228 Class 1 ... 5. The individual litz wires must have a min. diameter of 0.17 mm.
General	For HEAVYCON housing type B6 ... B48 and module carrier frame HC-M-B...MF-...

Mounting

Assembly note	To ensure correct use, installation in housing with IP54 protection or better is required
---------------	---

Product properties

Product type	Modular contact insert
Series	HC-M-08
Application	Power
Number of positions	8
Connection profile	8
Contact numbering	1 - 8
Number of module slots	1
No. of power contacts	8
No. of control contacts	0
Contact material type	turned

Insulation characteristics

Overvoltage category	III
Degree of pollution	3

Connection data

Connection technology

Connection technology	Push-in connection
-----------------------	--------------------

Conductor connection

Conductor cross-section	0.5 mm ² ... 2.5 mm ²
Connection cross section AWG	20 ... 14
Stripping length of the individual wire	10 mm

Dimensions

HC-M-08-PT-M - Contact insert module



1424227

<https://www.phoenixcontact.com/us/products/1424227>

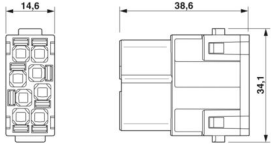
Dimensional drawing	
Width	34.1 mm
Height	39 mm
Length	14.6 mm

Mechanical characteristics

Contact diameter	2.5 mm
------------------	--------

Electrical properties

Rated voltage (III/2) contacts	690 V
Rated voltage (III/3)	400 V
Rated surge voltage (III/2)	4 kV
Rated surge voltage (III/3)	6 kV
Rated surge voltage	6 kV
Rated current	16 A (power contacts)
SCCR	5 kA (UL 2237)

Mechanical properties

Mechanical data

Insertion/withdrawal cycles	≥ 500
-----------------------------	-------

Material specifications

Flammability rating according to UL 94	V0
Contact material	Copper alloy
Contact surface material	Ag
Contact carrier material	PC

Environmental and real-life conditions

Ambient conditions

Ambient temperature (operation)	-40 °C ... 125 °C
---------------------------------	-------------------

HC-M-08-PT-M - Contact insert module



1424227

<https://www.phoenixcontact.com/us/products/1424227>

Drawings

Dimensional drawing

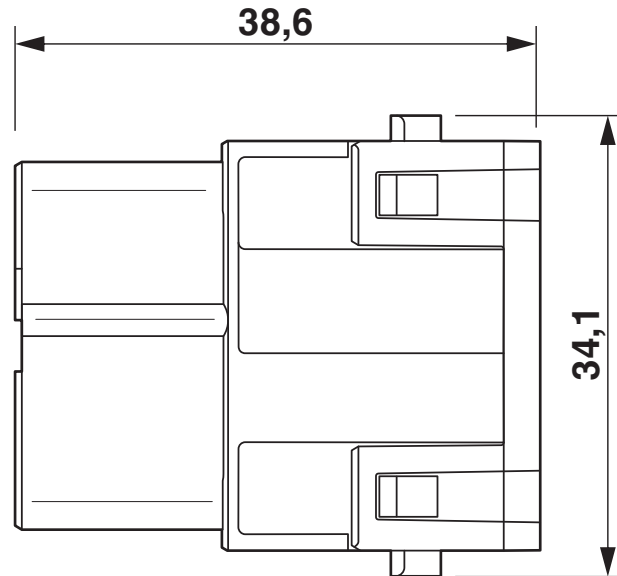
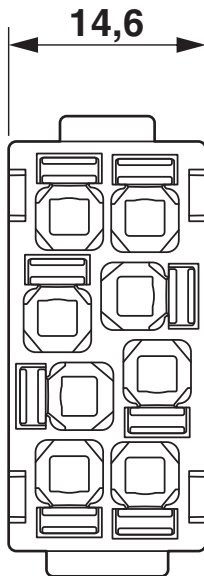

Dimensional drawing

HC-M-08-PT-M - Contact insert module

1424227

<https://www.phoenixcontact.com/us/products/1424227>



Schematic diagram

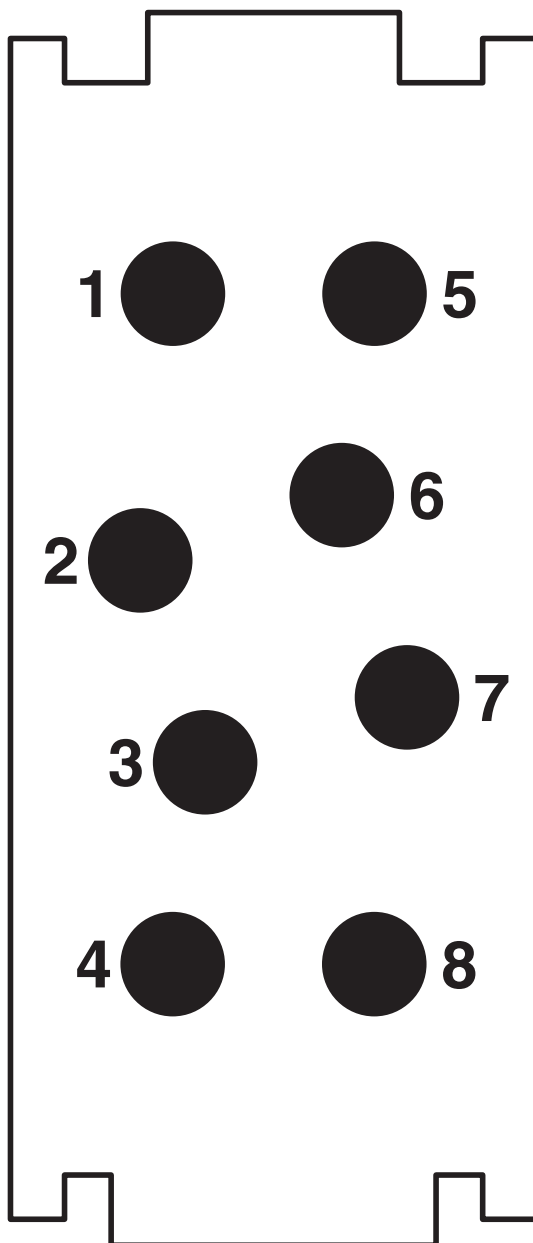

Connector pin assignment, connection side

Diagram

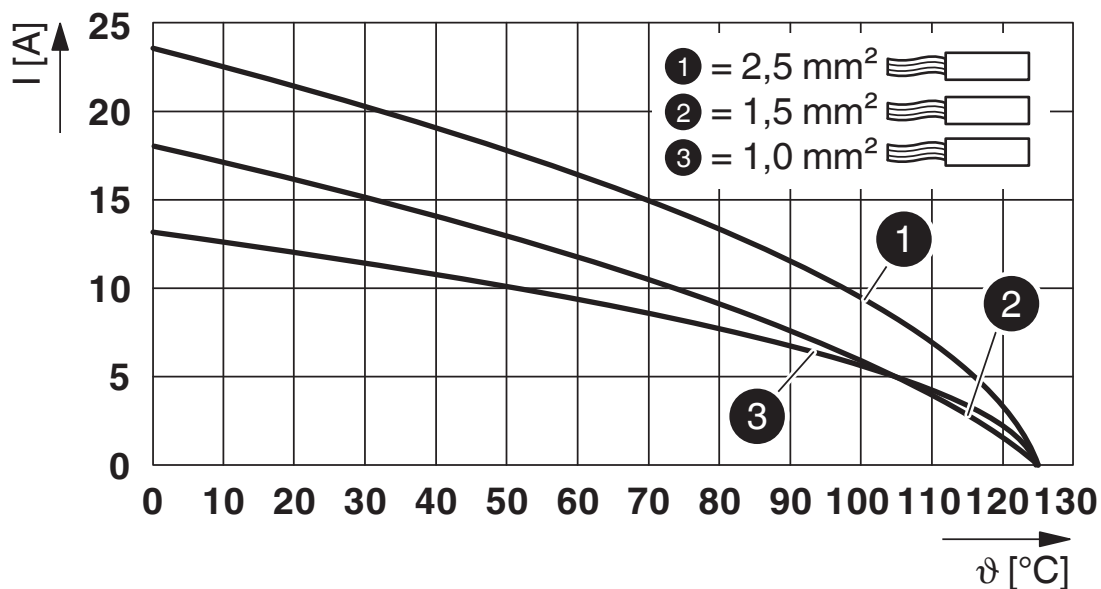

Derating diagram for flexible conductors

Diagram

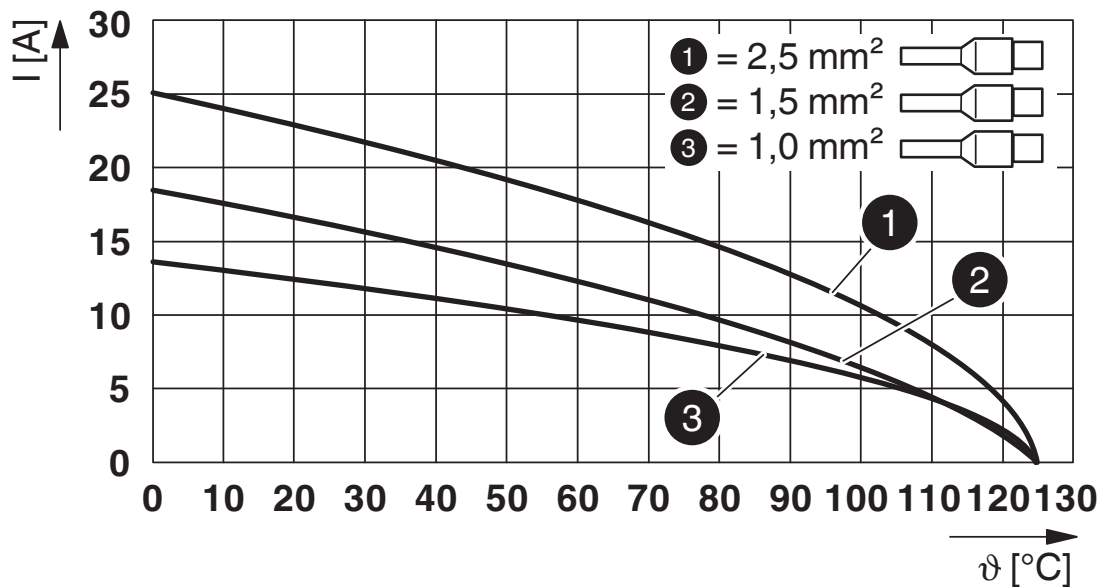

Derating diagram for flexible conductors with ferrule

HC-M-08-PT-M - Contact insert module



1424227

<https://www.phoenixcontact.com/us/products/1424227>

Approvals

To download certificates, visit the product detail page: <https://www.phoenixcontact.com/us/products/1424227>

 UL Recognized Approval ID: E468743				
	Nominal voltage U_N	Nominal current I_N	Cross section AWG	Cross section mm^2
keine				
	600 V	16 A	- 14	-

HC-M-08-PT-M - Contact insert module



1424227

<https://www.phoenixcontact.com/us/products/1424227>

Classifications

ECLASS

ECLASS-13.0	27440217
ECLASS-15.0	27440217

ETIM

ETIM 10.0	EC000438
-----------	----------

UNSPSC

UNSPSC 21.0	39121400
-------------	----------

HC-M-08-PT-M - Contact insert module



1424227

<https://www.phoenixcontact.com/us/products/1424227>

Environmental product compliance

EU RoHS

Fulfills EU RoHS substance requirements	Yes, No exemptions
---	--------------------

China RoHS

Environment friendly use period (EFUP)	EFUP-E
	No hazardous substances above the limits

EU REACH SVHC

REACH candidate substance (CAS No.)	No substance above 0.1 wt%
-------------------------------------	----------------------------

Phoenix Contact 2026 © - all rights reserved
<https://www.phoenixcontact.com>

Phoenix Contact USA
586 Fulling Mill Road
Middletown, PA 17057, United States
(+717) 944-1300
info@phoenixcon.com