

# SEALING PLUG 25X30 RD - Sealing plug



1421863

<https://www.phoenixcontact.com/us/products/1421863>

Please be informed that the data shown in this PDF document is generated from our online catalog. Please find the complete data in the user documentation. Our general terms of use for downloads are valid.

Sealing plug, color: red



## Commercial data

Item number	1421863
Packing unit	10 pc
Minimum order quantity	10 pc
Sales key	BF68
Product key	AF7DZX
GTIN	4055626287638
Weight per piece (including packing)	8.28 g
Weight per piece (excluding packing)	7.7 g
Customs tariff number	39235090
Country of origin	DE

# SEALING PLUG 25X30 RD - Sealing plug



1421863

<https://www.phoenixcontact.com/us/products/1421863>

## Technical data

### Product properties

Product type	Sealing plugs
--------------	---------------

### Dimensions

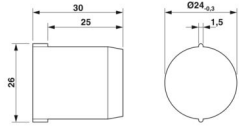
Dimensional drawing	
Length	30 mm
Diameter	24 mm

### Material specifications

Material	PA
----------	----

### Cable/line

Halogen-free	yes
--------------	-----

### Environmental and real-life conditions

#### Ambient conditions

Ambient temperature (operation)	-60 °C ... 100 °C
---------------------------------	-------------------

### Mounting

Assembly note	The head of the sealing plug must still be visible after mounting in the screw connection (see "after mounting" photo).
---------------	---

# SEALING PLUG 25X30 RD - Sealing plug



1421863

<https://www.phoenixcontact.com/us/products/1421863>

## Drawings

Dimensional drawing

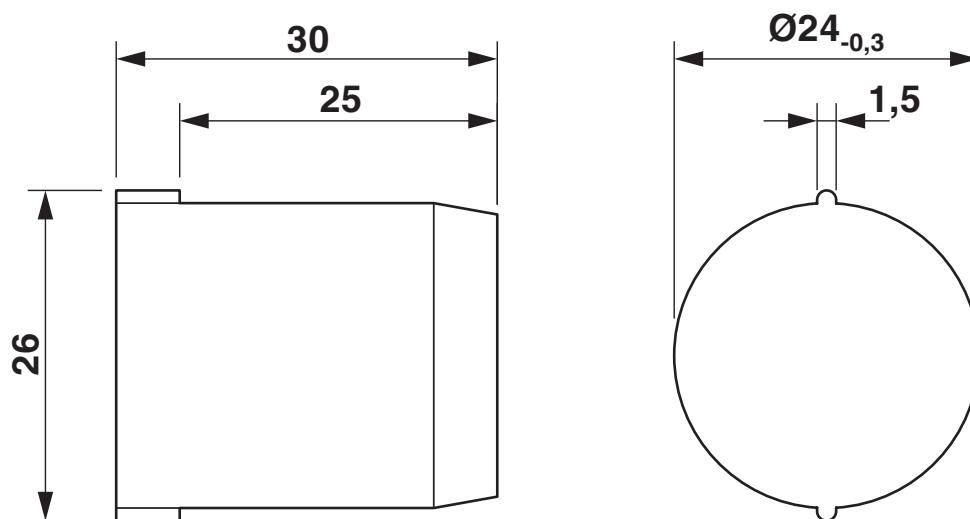

Dimensional drawing

# SEALING PLUG 25X30 RD - Sealing plug



1421863

<https://www.phoenixcontact.com/us/products/1421863>

## Classifications

### ECLASS

ECLASS-13.0	23111190
ECLASS-15.0	27144492

### ETIM

ETIM 10.0	EC002610
-----------	----------

### UNSPSC

UNSPSC 21.0	39121300
-------------	----------

# SEALING PLUG 25X30 RD - Sealing plug



1421863

<https://www.phoenixcontact.com/us/products/1421863>

## Environmental product compliance

### EU RoHS

Fulfills EU RoHS substance requirements	Yes, No exemptions
---	--------------------

### China RoHS

Environment friendly use period (EFUP)	EFUP-E
	No hazardous substances above the limits

### EU REACH SVHC

REACH candidate substance (CAS No.)	No substance above 0.1 wt%
-------------------------------------	----------------------------

Phoenix Contact 2026 © - all rights reserved  
<https://www.phoenixcontact.com>

Phoenix Contact USA  
586 Fulling Mill Road  
Middletown, PA 17057, United States  
(+717) 944-1300  
[info@phoenixcon.com](mailto:info@phoenixcon.com)