

# HC-ADV-B06-HLWH-1STM25-MF-BK - Housing



1420903

<https://www.phoenixcontact.com/us/products/1420903>

Please be informed that the data shown in this PDF document is generated from our online catalog. Please find the complete data in the user documentation. Our general terms of use for downloads are valid.



Sleeve housing B6, with screw locking, material: Die-cast aluminum, salt water resistant, cable outlets: 1, lateral, 1x M25, height: 74 mm, cable gland: none, increased environmental requirements

## Commercial data

Item number	1420903
Packing unit	1 pc
Minimum order quantity	1 pc
Sales key	BF58
Product key	AF7API
GTIN	4055626249025
Weight per piece (including packing)	207.9 g
Weight per piece (excluding packing)	207.9 g
Customs tariff number	85389099
Country of origin	CN

1420903

<https://www.phoenixcontact.com/us/products/1420903>

## Technical data

### Product properties

Product type	Housing with screw locking
Housing type	Sleeve housing
Product family	HC-ADV
Application	increased environmental requirements
Type	B6
No. of cable outlets	1
Type of the screw connection	1x M25
Fixing screws	M6 (screw head: 5 mm Allen screw)
Shielded	no
Cable outlet	lateral
Pg screw connection	none

### Connection data

Tightening torque	3 Nm ... 5 Nm (for M6 mounting screws on the sleeve housing)
-------------------	--------------------------------------------------------------

### Dimensions

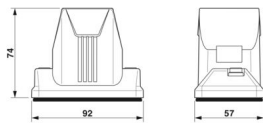
Dimensional drawing	
Width	57 mm
Height	74 mm
Length	92 mm

### Installation dimensions

Width of the assembly cutout	35 mm
Length of the assembly cutout	52 mm

### Material specifications

Seal material	Viton
Housing material	Die-cast aluminum, salt water resistant
Housing surface material	Powder-coated, black
Locking latch material	Stainless steel

### Environmental and real-life conditions

#### Ambient conditions

Degree of protection	IP66
	IP68 (0.2 bar/24 h)
	IP69 (ISO 20653:2013-02)

# HC-ADV-B06-HLWH-1STM25-MF-BK - Housing



1420903

<https://www.phoenixcontact.com/us/products/1420903>

Enclosure rating (NEMA)	4 (UL 50e)
	4X (UL 50e)
	12 (UL 50e)
Impact strength	IK09
Ambient temperature (operation)	-40 °C ... 125 °C

## Mechanical properties

### Mechanical data

Type of the screw connection	1x M25
Locking type	Screw

## Mounting

Fixing screws	M6 (screw head: 5 mm Allen screw)
---------------	-----------------------------------

1420903

<https://www.phoenixcontact.com/us/products/1420903>

## Drawings

Dimensional drawing



Dimensional drawing

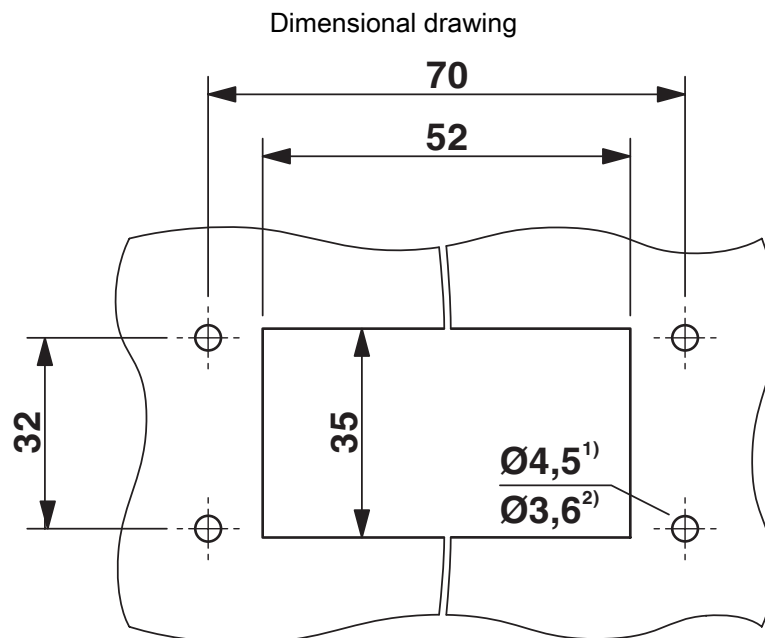

### Mounting cutout

1) when M4 screws are used

2) when self-tapping Torx® screws are used (Torx® 20, M4)

1420903

<https://www.phoenixcontact.com/us/products/1420903>

## Approvals

To download certificates, visit the product detail page: <https://www.phoenixcontact.com/us/products/1420903>

**DNV**

Approval ID: TAE000037S



**cUL Recognized**

Approval ID: E255026



**UL Recognized**

Approval ID: E255026



**EAC**

Approval ID: RU C-DE.AI30.B.01102

1420903

<https://www.phoenixcontact.com/us/products/1420903>

## Classifications

### ECLASS

ECLASS-13.0	27440202
ECLASS-15.0	27440202

### ETIM

ETIM 10.0	EC000437
-----------	----------

### UNSPSC

UNSPSC 21.0	31261500
-------------	----------

1420903

<https://www.phoenixcontact.com/us/products/1420903>

## Environmental product compliance

### EU RoHS

Fulfills EU RoHS substance requirements	Yes, No exemptions
-----------------------------------------	--------------------

### China RoHS

Environment friendly use period (EFUP)	EFUP-E
	No hazardous substances above the limits

### EU REACH SVHC

REACH candidate substance (CAS No.)	No substance above 0.1 wt%
-------------------------------------	----------------------------

Phoenix Contact 2026 © - all rights reserved  
<https://www.phoenixcontact.com>

Phoenix Contact USA  
586 Fulling Mill Road  
Middletown, PA 17057, United States  
(+717) 944-1300  
[info@phoenixcon.com](mailto:info@phoenixcon.com)