

SAC-6P- 1,0-U20/MINFS - Power cable



1416602

<https://www.phoenixcontact.com/us/products/1416602>

Please be informed that the data shown in this PDF document is generated from our online catalog. Please find the complete data in the user documentation. Our general terms of use for downloads are valid.



Power cable, 6-position, PVC, yellow, free cable end, on Socket straight 7/8"-16UNF, coding: A, cable length: 1 m

Your advantages

- Easy and safe: 100 % electrically tested plug-in components

Commercial data

Item number	1416602
Packing unit	1 pc
Minimum order quantity	1 pc
Note	Made to order (non-returnable)
Sales key	BF14
Product key	AF1IMB
GTIN	4055626223155
Weight per piece (including packing)	22.22 g
Weight per piece (excluding packing)	22.22 g
Customs tariff number	85444290
Country of origin	MX

SAC-6P- 1,0-U20/MINFS - Power cable



1416602

<https://www.phoenixcontact.com/us/products/1416602>

Technical data

Product properties

Product type	Sensor/actuator cable
Application	Standard
Number of positions	6
No. of cable outlets	1
Shielded	no
Coding	A

Material specifications

Flammability rating according to UL 94	V0
Material of grip body	PVC
Contact material	CuZn
Contact surface material	Au
Contact carrier material	PVC
Material for screw connection	Anodized aluminum

Electrical properties

Insulation resistance	$\geq 100 \text{ M}\Omega$
Nominal voltage U_N	600 V AC/DC (UL rating)
	50 V AC/DC (IEC rating)
Nominal current I_N	8 A

Mechanical properties

Mechanical data

Insertion/withdrawal cycles	100
-----------------------------	-----

Signaling

Status display	no
Status display present	no

Connection data

Conductor connection

Tightening torque	10 lb _F ·in.
	1.12 Nm

Connector

Connection 1

Type	free cable end
------	----------------

Connection 2

Type	Socket straight 7/8"-16UNF
------	----------------------------

SAC-6P- 1,0-U20/MINFS - Power cable



1416602

<https://www.phoenixcontact.com/us/products/1416602>

Number of positions	6
Coding type	A

Cable/line

Cable length	1 m
--------------	-----

Yellow, STOOW [U20]

Number of positions	6
Shielded	no
Cable type	Yellow, STOOW [U20]
Conductor structure, voltage supply	65 x AWG 32
Conductor cross-section	6 x AWG 16
External cable diameter	13.70 mm
Outer sheath, material	PVC
External sheath, color	yellow
Conductor material	Bare Cu litz wires
Single wire, color	white 1, red 2, green 3, orange 4, black 5, blue 6
Nominal voltage, cable	600 V
Minimum bending radius, fixed installation	4 x D
Minimum bending radius, flexible installation	12.5 x D
Smallest bending radius, fixed installation	55 mm
Smallest bending radius, movable installation	172 mm
Flame resistance	UL 1581, FT2
Resistance to oil	Premium oil resistance (jacket and conductor)
Other resistance	UV resistant (720 h) (UL 2556)
Ambient temperature (operation)	-40 °C ... 105 °C (cable, fixed installation) -30 °C ... 105 °C (Cable, flexible installation)

Environmental and real-life conditions

Ambient conditions

Degree of protection	IP68
Ambient temperature (operation) (male connector/female connector)	-20 °C ... 105 °C (Plug / socket)
Ambient temperature (operation) (Cable, fixed installation)	-40 °C ... 105 °C (cable, fixed installation)
Ambient temperature (operation) (Cable, flexible installation)	-30 °C ... 105 °C (Cable, flexible installation)

SAC-6P- 1,0-U20/MINFS - Power cable



1416602

<https://www.phoenixcontact.com/us/products/1416602>

Drawings



7/8"-16UNF socket, straight

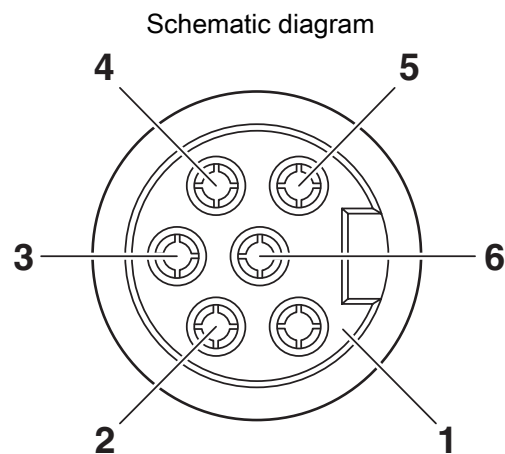

Pin assignment, socket, 7/8"-16UNF, 6-pos., view of female side

SAC-6P- 1,0-U20/MINFS - Power cable



1416602

<https://www.phoenixcontact.com/us/products/1416602>

Circuit diagram



Contact assignment of 7/8" socket

SAC-6P- 1,0-U20/MINFS - Power cable



1416602

<https://www.phoenixcontact.com/us/products/1416602>

Approvals

To download certificates, visit the product detail page: <https://www.phoenixcontact.com/us/products/1416602>



UL Listed

Approval ID: FILE E 221474



cUL Listed

Approval ID: FILE E 221474

SAC-6P- 1,0-U20/MINFS - Power cable



1416602

<https://www.phoenixcontact.com/us/products/1416602>

Classifications

ECLASS

ECLASS-13.0	27060311
ECLASS-15.0	27060311

ETIM

ETIM 10.0	EC001855
-----------	----------

UNSPSC

UNSPSC 21.0	31251501
-------------	----------

SAC-6P- 1,0-U20/MINFS - Power cable



1416602

<https://www.phoenixcontact.com/us/products/1416602>

Environmental product compliance

EU RoHS

Fulfills EU RoHS substance requirements	Yes, No exemptions
---	--------------------

China RoHS

Environment friendly use period (EFUP)	EFUP-E
	No hazardous substances above the limits

EU REACH SVHC

REACH candidate substance (CAS No.)	No substance above 0.1 wt%
-------------------------------------	----------------------------

Phoenix Contact 2026 © - all rights reserved
<https://www.phoenixcontact.com>

Phoenix Contact USA
586 Fulling Mill Road
Middletown, PA 17057, United States
(+717) 944-1300
info@phoenixcon.com