

SAC-3P-M 8MS/1,5-PVC/M 8FR-2L - Sensor/actuator cable



1415898

<https://www.phoenixcontact.com/us/products/1415898>

Please be informed that the data shown in this PDF document is generated from our online catalog. Please find the complete data in the user documentation. Our general terms of use for downloads are valid.



Sensor/actuator cable, 3-position, PVC, black RAL 9005, Plug straight M8, coding: A, with 2 LEDs, on Socket angled M8, coding: A, with 2 LEDs, cable length: 1.5 m

Your advantages

- Easy and safe: 100 % electrically tested plug-in components
- Convenient: increased machine availability thanks to quick and easy diagnostics

Commercial data

Item number	1415898
Packing unit	1 pc
Minimum order quantity	1 pc
Sales key	BF01
Product key	AF1BBA
GTIN	4055626054667
Weight per piece (including packing)	48.2 g
Weight per piece (excluding packing)	48.2 g
Customs tariff number	85444290
Country of origin	PL

SAC-3P-M 8MS/1,5-PVC/M 8FR-2L - Sensor/actuator cable



1415898

<https://www.phoenixcontact.com/us/products/1415898>

Technical data

Product properties

Product type	Sensor/actuator cable
Application	Standard
Number of positions	3
No. of cable outlets	1
Shielded	no
Coding	A

Insulation characteristics

Overvoltage category	II
Degree of pollution	3

Material specifications

Flammability rating according to UL 94	HB
Seal material	NBR
Material of grip body	TPU, hardly inflammable, self-extinguishing
Contact material	CuSn
Contact surface material	Ni/Au
Contact carrier material	TPU GF
Material for screw connection	Zinc die-cast, nickel-plated

Electrical properties

Insulation resistance	$\geq 100 \text{ M}\Omega$
Nominal voltage U_N	24 V DC
Nominal current I_N	4 A

Mechanical properties

Mechanical data

Insertion/withdrawal cycles	≥ 100
-----------------------------	------------

Signaling

Status display	2 LEDs
Status display present	yes

Connector

Connection 1

Type	Plug straight M8
Number of positions	3
Coding type	A

Connection 2

Type	Socket angled M8
------	------------------

SAC-3P-M 8MS/1,5-PVC/M 8FR-2L - Sensor/actuator cable

1415898

<https://www.phoenixcontact.com/us/products/1415898>

Number of positions	3
Coding type	A

Cable/line

Cable length	1.5 m
--------------	-------

PVC black [PVC]

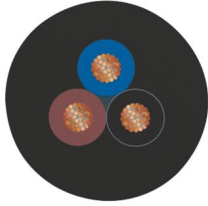
Dimensional drawing	
Cable weight	29 kg/km
Number of positions	3
Shielded	no
Cable type	PVC black [PVC]
Conductor structure signal line	14x 0.15 mm
AWG signal line	24
Conductor cross-section	3x 0.25 mm ² (Signal line)
Wire diameter incl. insulation	1.17 mm ±0.05 mm
External cable diameter	4.20 mm ±0.15 mm
Outer sheath, material	PVC
External sheath, color	black RAL 9005
Conductor material	Bare Cu litz wires
Material wire insulation	PVC
Single wire, color	brown, blue, black
Thickness, insulation	≥ 0.23 mm (Core insulation)
Thickness, outer sheath	≥ 0.76 mm
Overall twist	3 wires, twisted
Max. conductor resistance	max. 79 Ω/km (at 20 °C)
Insulation resistance	≥ 100 MΩ*km (at 20 °C)
Nominal voltage, cable	≥ 300 V
Test voltage	≤ 3000 V
Smallest bending radius, fixed installation	13 mm
Flame resistance	As per UL-Style 2464
Resistance to oil	EN 60811-2-1
Ambient temperature (operation)	-25 °C ... 80 °C (cable, fixed installation) -10 °C ... 80 °C (Cable, flexible installation)

Environmental and real-life conditions

Ambient conditions

SAC-3P-M 8MS/1,5-PVC/M 8FR-2L - Sensor/actuator cable



1415898

<https://www.phoenixcontact.com/us/products/1415898>

Degree of protection	IP65
	IP67
	IP68
Ambient temperature (operation) (male connector/female connector)	-25 °C ... 90 °C (Plug / socket)

Standards and regulations

M8

Standard designation	M8 connector
Standards/specifications	IEC 61076-2-104

SAC-3P-M 8MS/1,5-PVC/M 8FR-2L - Sensor/actuator cable

1415898

<https://www.phoenixcontact.com/us/products/1415898>

Drawings

Dimensional drawing



M8 x 1 male plug, straight version

Dimensional drawing



Socket M8 x 1, angled

SAC-3P-M 8MS/1,5-PVC/M 8FR-2L - Sensor/actuator cable

1415898

<https://www.phoenixcontact.com/us/products/1415898>

Schematic diagram



Pin assignment M8 plug, 3-pos., view male side

Schematic diagram



Pin assignment M8 socket, 3-pos., view female side

SAC-3P-M 8MS/1,5-PVC/M 8FR-2L - Sensor/actuator cable

1415898

<https://www.phoenixcontact.com/us/products/1415898>

Schematic diagram



Layout of connector pin assignments

Circuit diagram

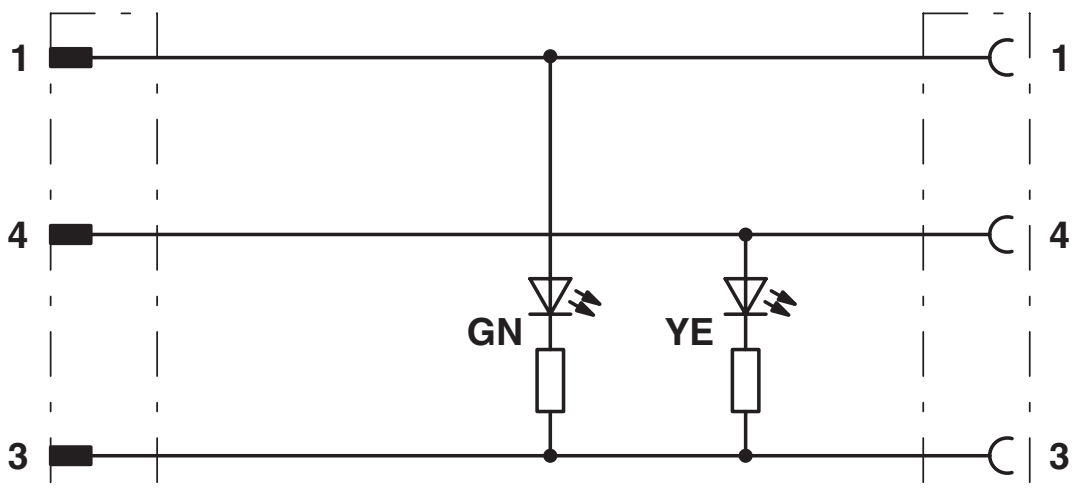

Contact assignment of M8 plugs/sockets

SAC-3P-M 8MS/1,5-PVC/M 8FR-2L - Sensor/actuator cable



1415898

<https://www.phoenixcontact.com/us/products/1415898>

Approvals

To download certificates, visit the product detail page: <https://www.phoenixcontact.com/us/products/1415898>

 UL Listed Approval ID: FILE E 221474				
	Nominal voltage U_N	Nominal current I_N	Cross section AWG	Cross section mm^2
keine				
	24 V	4 A	-	-

 cUL Listed Approval ID: FILE E 221474				
	Nominal voltage U_N	Nominal current I_N	Cross section AWG	Cross section mm^2
keine				
	24 V	4 A	-	-

 EAC-RoHS Approval ID: RU D-DE.HB35.B.00387	
--	--

SAC-3P-M 8MS/1,5-PVC/M 8FR-2L - Sensor/actuator cable



1415898

<https://www.phoenixcontact.com/us/products/1415898>

Classifications

ECLASS

ECLASS-13.0	27060311
ECLASS-15.0	27060311

ETIM

ETIM 10.0	EC001855
-----------	----------

UNSPSC

UNSPSC 21.0	26121600
-------------	----------

SAC-3P-M 8MS/1,5-PVC/M 8FR-2L - Sensor/actuator cable



1415898

<https://www.phoenixcontact.com/us/products/1415898>

Environmental product compliance

EU RoHS

Fulfills EU RoHS substance requirements	Yes, No exemptions
---	--------------------

China RoHS

Environment friendly use period (EFUP)	EFUP-E
	No hazardous substances above the limits

EU REACH SVHC

REACH candidate substance (CAS No.)	No substance above 0.1 wt%
-------------------------------------	----------------------------

EF3.1 Climate Change

CO2e kg	0.372 kg CO2e
---------	---------------

Phoenix Contact 2026 © - all rights reserved
<https://www.phoenixcontact.com>

Phoenix Contact USA
586 Fulling Mill Road
Middletown, PA 17057, United States
(+717) 944-1300
info@phoenixcon.com