

# SAC-5P-10,0-PUR/M12FRK PE SH - Power cable



1414818

<https://www.phoenixcontact.com/us/products/1414818>

Please be informed that the data shown in this PDF document is generated from our online catalog. Please find the complete data in the user documentation. Our general terms of use for downloads are valid.

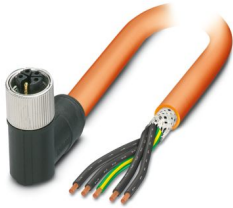

Power cable, 5-position, PUR halogen-free, orange RAL 2003, shielded (Advanced Shielding Technology), free cable end, on Socket angled M12, coding: K, cable length: 10 m, for AC current up to 16 A/690 V

## Your advantages

- Easy and safe: 100 % electrically tested plug-in components
- Protection against mismatching, thanks to special K-coding
- Shield power reliably – 360° shielding to reduce electromagnetic loads
- Our standard: robust halogen-free PUR cable

## Commercial data

Item number	1414818
Packing unit	1 pc
Minimum order quantity	1 pc
Sales key	BF05
Product key	AF1CDQ
GTIN	4055626034515
Weight per piece (including packing)	1,992.76 g
Weight per piece (excluding packing)	1,992.76 g
Customs tariff number	85444290
Country of origin	PL

1414818

<https://www.phoenixcontact.com/us/products/1414818>

## Technical data

### Product properties

Product type	Power cable
Application	Energy supply
Number of positions	5
No. of cable outlets	1
Shielded	yes
Coding	K

### Insulation characteristics

Overvoltage category	III
Degree of pollution	3

### Material specifications

Flammability rating according to UL 94	V0
Material of grip body	PP
Contact material	CuZn
Contact surface material	Ni/Au
Contact carrier material	PA
Material for screw connection	Zinc die-cast, nickel-plated

### Electrical properties

Insulation resistance	$\geq 100 \text{ M}\Omega$
Nominal voltage $U_N$	690 V AC
Nominal current $I_N$	16 A

### Mechanical properties

#### Mechanical data

Insertion/withdrawal cycles	$\geq 100$
-----------------------------	------------

### Connector

#### Connection 1

Type	free cable end
------	----------------

#### Connection 2

Type	Socket angled M12
Coding type	K (Power)

### Cable/line

Cable length	10 m
--------------	------

PUR halogen-free orange [PUR]

# SAC-5P-10,0-PUR/M12FRK PE SH - Power cable



1414818

<https://www.phoenixcontact.com/us/products/1414818>

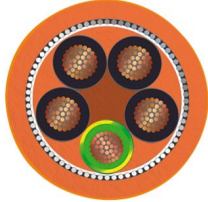
Dimensional drawing	
Cable weight	195 kg/km
UL AWM Style	90 °C / 1000 V
Number of positions	5
Shielded	yes
Cable type	PUR halogen-free orange [PUR]
Conductor structure, voltage supply	80x 0.20 mm
AWG power supply	16
Conductor cross-section	5x 2.5 mm <sup>2</sup>
Wire diameter incl. insulation	2.8 mm ±0.1 mm
External cable diameter	9.90 mm ±0.3 Nm
Outer sheath, material	PUR
External sheath, color	orange RAL 2003
Conductor material	Bare Cu litz wires
Material wire insulation	PP
Single wire, color	black 1, black 2, black 3, black 4, green/yellow
Thickness, insulation	≥ 0.26 mm
Thickness, outer sheath	approx. 0.75 mm
Overall twist	5 cores, twisted
Max. conductor resistance	≤ 8 Ω/km (at 20 °C)
Insulation resistance	≥ 1 GΩ*km (at 20 °C)
Nominal voltage, cable	≤ 1000 V AC
Test voltage	≥ 10000 V AC (Spark test)
Minimum bending radius, fixed installation	5 x D
Minimum bending radius, flexible installation	10 x D
Smallest bending radius, fixed installation	49 mm
Smallest bending radius, movable installation	99 mm
Dynamic load capacity (bending)	Max. bending cycles: 5000000, Bending radius: 10 x D, Traversing path: 10 m, Traversing rate: 3 m/s, Acceleration: 10 m/s <sup>2</sup>
Dynamic load capacity (torsion)	Torsion: ±180 °/m, Torsion cycles: 500000, Torsional frequency: 35 cycles/min.
Halogen-free	in accordance with DIN VDE 0472 part 815 in accordance with DIN EN 50267-2-1
Flame resistance	According to UL 758/1581 (Cable Flame) in accordance with UL 758/1581 FT2 according to DIN EN 60332-2-2

# SAC-5P-10,0-PUR/M12FRK PE SH - Power cable



1414818

<https://www.phoenixcontact.com/us/products/1414818>

Resistance to oil	according to DIN EN 60811-404, 168 h at 100 °C
	according to UL 758, 168 h at 60 °C
Other resistance	Hydrolysis and microbe resistant as per VDE 0282 section 10
	Low adhesion
	abrasion-resistant
	Resistant to salt water
Ambient temperature (operation)	-50 °C ... 85 °C (cable, fixed installation)
	-30 °C ... 85 °C (Cable, flexible installation)

## Environmental and real-life conditions

### Ambient conditions

Degree of protection	IP65
	IP67 (without preloading, as additional test in accordance with IEC 60529)
Ambient temperature (operation) (male connector/female connector)	-25 °C ... 85 °C (Plug / socket)

## Standards and regulations

Standard designation	M12 connector
Standards/specifications	IEC 61076-2-111

# SAC-5P-10,0-PUR/M12FRK PE SH - Power cable

1414818

<https://www.phoenixcontact.com/us/products/1414818>



## Drawings

Dimensional drawing

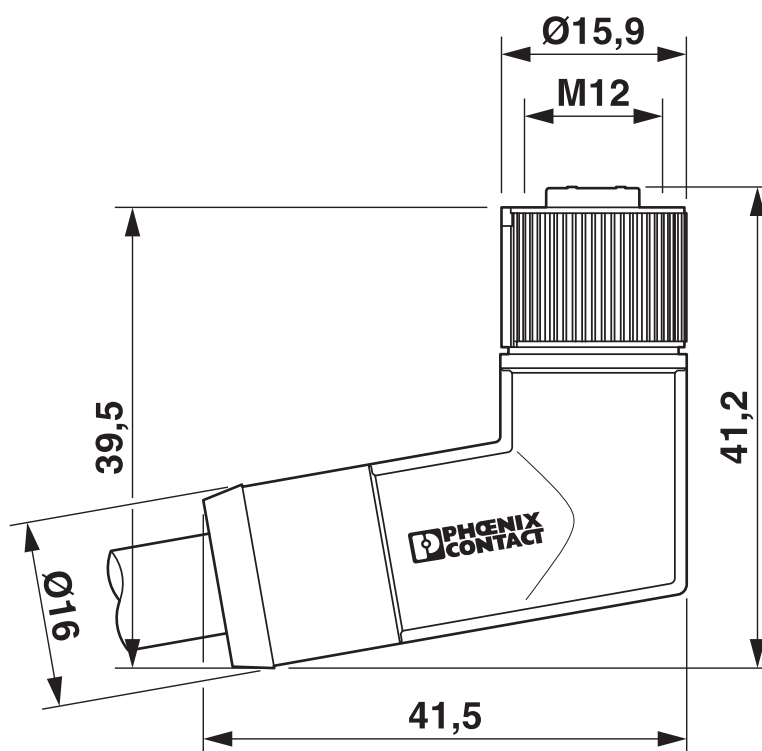

M12 x 1 socket, angled

1414818

<https://www.phoenixcontact.com/us/products/1414818>

Schematic diagram

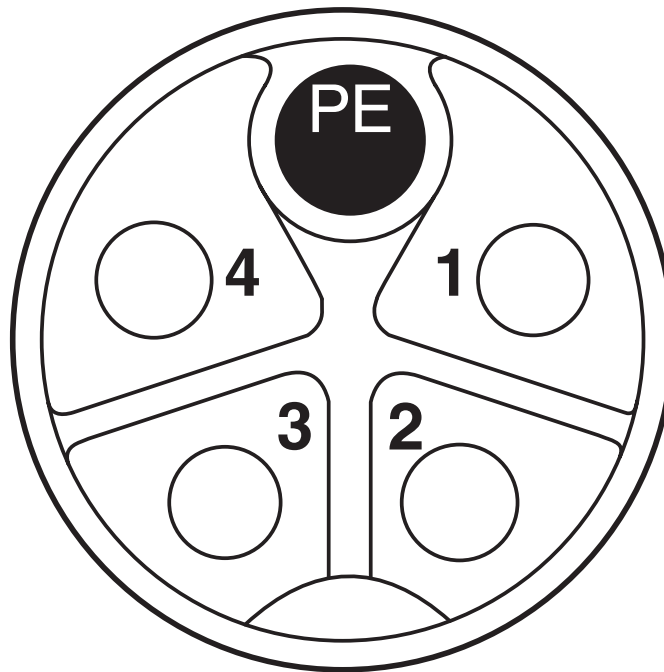

Pin assignment of M12 socket, 5-pos., K-coded, socket side view

Diagram

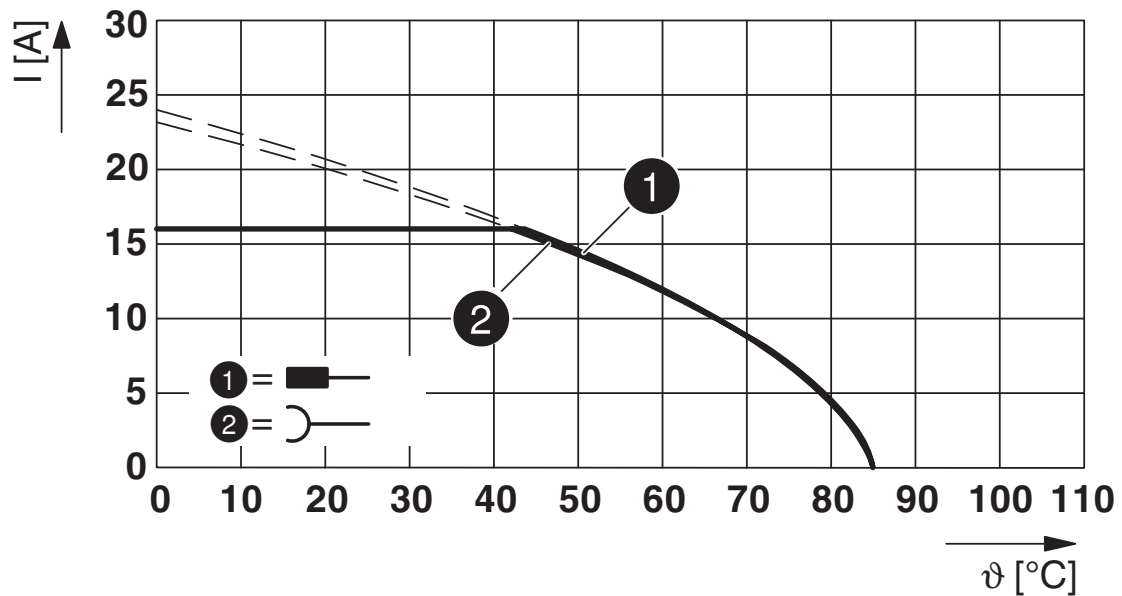

Base curve

# SAC-5P-10,0-PUR/M12FRK PE SH - Power cable



1414818

<https://www.phoenixcontact.com/us/products/1414818>

Circuit diagram

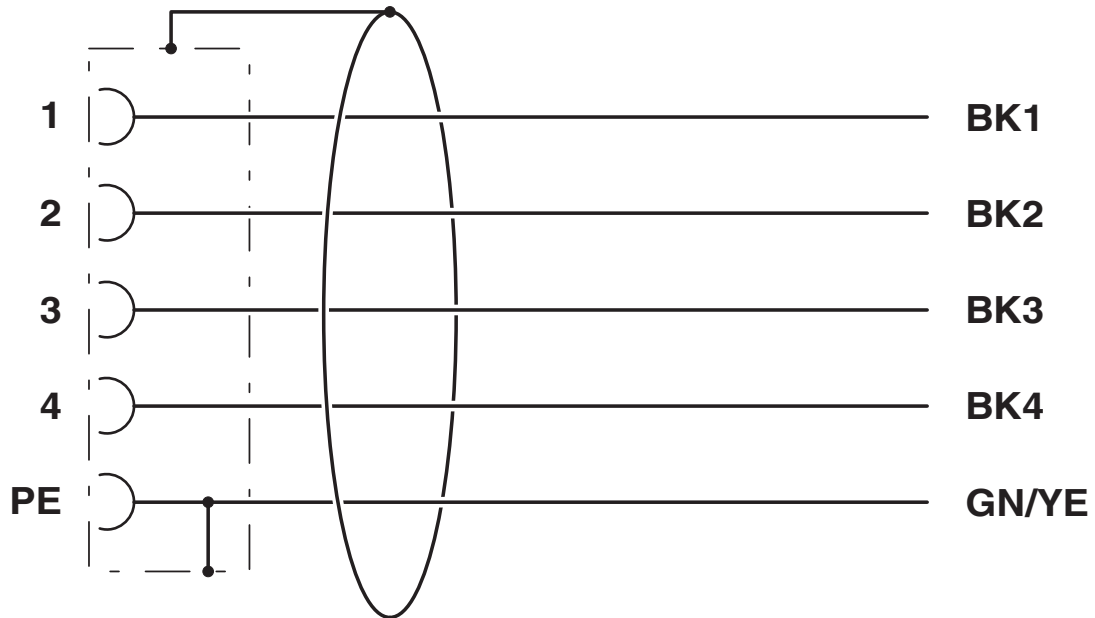

Contact assignment of the M12 socket

# SAC-5P-10,0-PUR/M12FRK PE SH - Power cable





1414818

<https://www.phoenixcontact.com/us/products/1414818>

## Approvals

To download certificates, visit the product detail page: <https://www.phoenixcontact.com/us/products/1414818>

 <b>UL Listed</b> Approval ID: E468743				
	Nominal voltage $U_N$	Nominal current $I_N$	Cross section AWG	Cross section $\text{mm}^2$
keine				
	600 V	16 A	- 14	- 14

 <b>cUL Listed</b> Approval ID: E468743				
	Nominal voltage $U_N$	Nominal current $I_N$	Cross section AWG	Cross section $\text{mm}^2$
keine				
	600 V	16 A	- 14	-

 <b>EAC-RoHS</b> Approval ID: RU D-DE.HB35.B.00387	
--	--



# SAC-5P-10,0-PUR/M12FRK PE SH - Power cable



1414818

<https://www.phoenixcontact.com/us/products/1414818>

## Classifications

### ECLASS

ECLASS-13.0	27060327
ECLASS-15.0	27060327

### ETIM

ETIM 10.0	EC001855
-----------	----------

### UNSPSC

UNSPSC 21.0	26121600
-------------	----------

# SAC-5P-10,0-PUR/M12FRK PE SH - Power cable



1414818

<https://www.phoenixcontact.com/us/products/1414818>

## Environmental product compliance

### EU RoHS

Fulfills EU RoHS substance requirements	Yes, No exemptions
---	--------------------

### China RoHS

Environment friendly use period (EFUP)	EFUP-E
	No hazardous substances above the limits

### EU REACH SVHC

REACH candidate substance (CAS No.)	No substance above 0.1 wt%
-------------------------------------	----------------------------

### EF3.1 Climate Change

CO2e kg	12.264 kg CO2e
---------	----------------

Phoenix Contact 2026 © - all rights reserved  
<https://www.phoenixcontact.com>

Phoenix Contact USA  
586 Fulling Mill Road  
Middletown, PA 17057, United States  
(+717) 944-1300  
[info@phoenixcon.com](mailto:info@phoenixcon.com)