

# HC-STA-B06-HLFS-1TTP16-EL-AL - Housing



1412577

<https://www.phoenixcontact.com/us/products/1412577>

Please be informed that the data shown in this PDF document is generated from our online catalog. Please find the complete data in the user documentation. Our general terms of use for downloads are valid.



Sleeve housing B6, for single locking latch, material: Die-cast aluminum, salt water resistant, cable outlets: 1, straight, 1x Pg16, height: 52 mm, cable gland: none, Standard

## Your advantages

- Good shielding in the event of electromagnetic interference

## Commercial data

Item number	1412577
Packing unit	1 pc
Minimum order quantity	1 pc
Sales key	BF56
Product key	AF7APB
GTIN	4055626059174
Weight per piece (including packing)	114.4 g
Weight per piece (excluding packing)	116.4 g
Customs tariff number	85389099
Country of origin	PL

1412577

<https://www.phoenixcontact.com/us/products/1412577>

## Technical data

### Product properties

Product type	Housing with locking latch
Housing type	Sleeve housing
Application	Standard
Type	B6
No. of cable outlets	1
Type of the screw connection	1x Pg16
Cable outlet	straight
Pg screw connection	none

### Dimensions

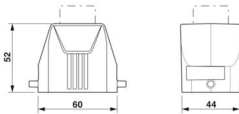
Dimensional drawing	
Width	44 mm
Height	52 mm
Length	60 mm

### Material specifications

Housing material	Die-cast aluminum, salt water resistant
Housing surface material	uncoated

### Mechanical properties

#### Mechanical data

Type of the screw connection	1x Pg16
Locking type	Pin

### Environmental and real-life conditions

#### Ambient conditions

Degree of protection	IP66 IP67
Enclosure rating (NEMA)	4 (UL 50e) 4X (UL 50e) 12 (UL 50e)
Impact strength	IK08
Ambient temperature (operation)	-40 °C ... 125 °C

# HC-STA-B06-HLFS-1TTP16-EL-AL - Housing



1412577

<https://www.phoenixcontact.com/us/products/1412577>

## Drawings

Dimensional drawing

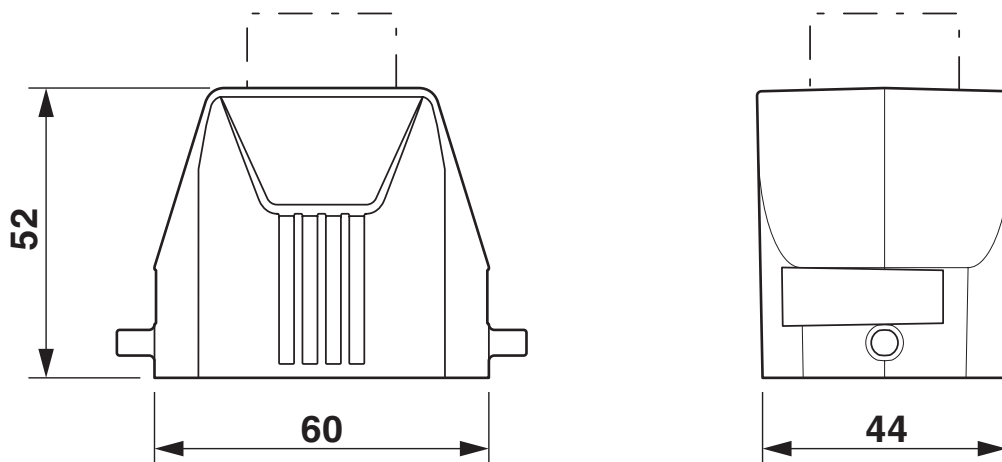

Dimensional drawing

1412577

<https://www.phoenixcontact.com/us/products/1412577>

## Approvals

To download certificates, visit the product detail page: <https://www.phoenixcontact.com/us/products/1412577>

**DNV**

Approval ID: TAE000037S



**cUL Recognized**

Approval ID: E255026



**UL Recognized**

Approval ID: E255026



**EAC**

Approval ID: RU C-DE.AI30.B.01102

1412577

<https://www.phoenixcontact.com/us/products/1412577>

## Classifications

### ECLASS

ECLASS-13.0	27440202
ECLASS-15.0	27440202

### ETIM

ETIM 10.0	EC000437
-----------	----------

### UNSPSC

UNSPSC 21.0	31261500
-------------	----------

1412577

<https://www.phoenixcontact.com/us/products/1412577>

## Environmental product compliance

### EU RoHS

Fulfills EU RoHS substance requirements	Yes, No exemptions
---	--------------------

### China RoHS

Environment friendly use period (EFUP)	EFUP-E
	No hazardous substances above the limits

### EU REACH SVHC

REACH candidate substance (CAS No.)	No substance above 0.1 wt%
-------------------------------------	----------------------------

### EF3.1 Climate Change

CO2e kg	2.393 kg CO2e
---------	---------------

Phoenix Contact 2026 © - all rights reserved  
<https://www.phoenixcontact.com>

Phoenix Contact USA  
586 Fulling Mill Road  
Middletown, PA 17057, United States  
(+717) 944-1300  
[info@phoenixcon.com](mailto:info@phoenixcon.com)