

HC-STA-B06-CHWS-1TTP29-ELC-AL - Housing



1412560

<https://www.phoenixcontact.com/us/products/1412560>

Please be informed that the data shown in this PDF document is generated from our online catalog. Please find the complete data in the user documentation. Our general terms of use for downloads are valid.



Coupling housings B6, with single locking latch, material: Die-cast aluminum, salt water resistant, cable outlets: 1, straight, 1x Pg29, height: 73 mm, cable gland: none, Standard

Your advantages

- Good shielding in the event of electromagnetic interference

Commercial data

Item number	1412560
Packing unit	1 pc
Minimum order quantity	1 pc
Sales key	BF56
Product key	AF7APB
GTIN	4055626030524
Weight per piece (including packing)	181.6 g
Weight per piece (excluding packing)	187.1 g
Customs tariff number	85389099
Country of origin	CN

1412560

<https://www.phoenixcontact.com/us/products/1412560>

Technical data

Product properties

Product type	Housing with locking latch
Housing type	Coupling housings
Application	Standard
Type	B6
No. of cable outlets	1
Type of the screw connection	1x Pg29
Cable outlet	straight
Pg screw connection	none

Dimensions

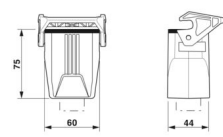
Dimensional drawing	
Width	44 mm
Height	73 mm
Length	60 mm

Material specifications

Flammability rating according to UL 94	V0 (Interlock)
Seal material	NBR, conductive
Housing material	Die-cast aluminum, salt water resistant
Housing surface material	uncoated
Locking latch material	PA

Mechanical properties

Mechanical data

Type of the screw connection	1x Pg29
Locking type	Latch

Environmental and real-life conditions

Ambient conditions

Degree of protection	IP66
	IP67
Enclosure rating (NEMA)	4 (UL 50e)
	4X (UL 50e)
	12 (UL 50e)
Impact strength	IK08

HC-STA-B06-CHWS-1TTP29-ELC-AL - Housing



1412560

<https://www.phoenixcontact.com/us/products/1412560>

Ambient temperature (operation)

-40 °C ... 125 °C

1412560

<https://www.phoenixcontact.com/us/products/1412560>

Drawings

Dimensional drawing

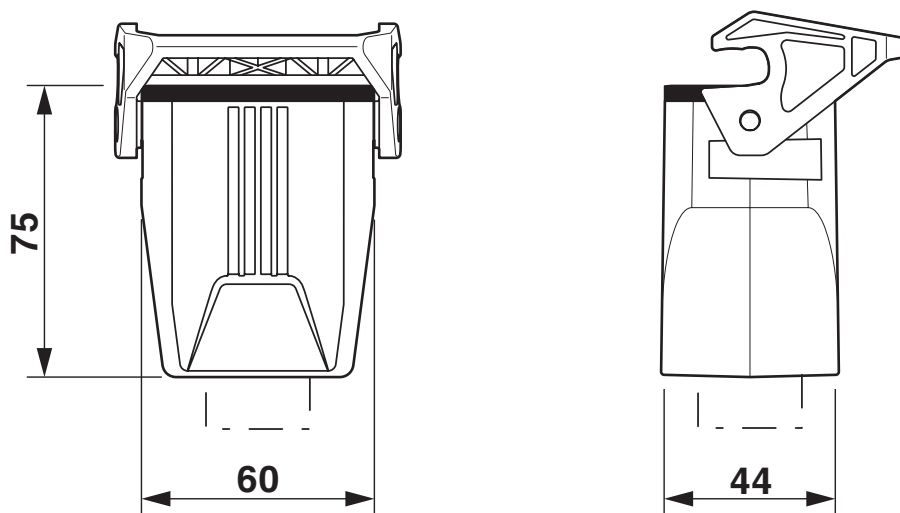

Dimensional drawing

1412560

<https://www.phoenixcontact.com/us/products/1412560>

Approvals

To download certificates, visit the product detail page: <https://www.phoenixcontact.com/us/products/1412560>

DNV

Approval ID: TAE000037S



cUL Recognized

Approval ID: E255026



UL Recognized

Approval ID: E255026



EAC

Approval ID: RU C-DE.AI30.B.01102

1412560

<https://www.phoenixcontact.com/us/products/1412560>

Classifications

ECLASS

ECLASS-13.0	27440202
ECLASS-15.0	27440202

ETIM

ETIM 10.0	EC000437
-----------	----------

UNSPSC

UNSPSC 21.0	31261500
-------------	----------

1412560

<https://www.phoenixcontact.com/us/products/1412560>

Environmental product compliance

EU RoHS

Fulfills EU RoHS substance requirements	Yes, No exemptions
---	--------------------

China RoHS

Environment friendly use period (EFUP)	EFUP-E
	No hazardous substances above the limits

EU REACH SVHC

REACH candidate substance (CAS No.)	No substance above 0.1 wt%
-------------------------------------	----------------------------

EF3.1 Climate Change

CO2e kg	3.426 kg CO2e
---------	---------------

Phoenix Contact 2026 © - all rights reserved
<https://www.phoenixcontact.com>

Phoenix Contact USA
586 Fulling Mill Road
Middletown, PA 17057, United States
(+717) 944-1300
info@phoenixcon.com