

HC-EVO-B16PT-BWD-HH-M25ELC-AL - Connector set



1411489

<https://www.phoenixcontact.com/us/products/1411489>

Please be informed that the data shown in this PDF document is generated from our online catalog. Please find the complete data in the user documentation. Our general terms of use for downloads are valid.



EVO connector set, B16 series, metal housing, consisting of: sleeve housing 1411460, panel mounting base 1411327, EVO screw connection 1411446, pin contact insert 1407732, socket contact insert 1407731

Commercial data

Item number	1411489
Packing unit	1 pc
Minimum order quantity	1 pc
Sales key	BF63
Product key	AF7AFX
GTIN	4046356932899
Weight per piece (including packing)	629.3 g
Weight per piece (excluding packing)	622.5 g
Customs tariff number	85366990
Country of origin	CN

HC-EVO-B16PT-BWD-HH-M25ELC-AL - Connector set



1411489

<https://www.phoenixcontact.com/us/products/1411489>

Set consists of

HC-B16-I-PT-F - Contact insert

1407731

<https://www.phoenixcontact.com/us/products/1407731>



Contact insert, number of positions: 16+PE, size: B16, number of connections per position: 1, Socket, Push-in connection, 500 V, 16 A, 0.14 mm² ... 2.5 mm², application: Power

HC-B16-I-PT-M - Contact insert

1407732

<https://www.phoenixcontact.com/us/products/1407732>

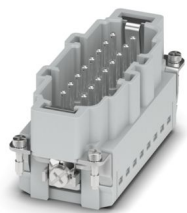

Contact insert, number of positions: 16+PE, size: B16, number of connections per position: 1, Pin, Push-in connection, 500 V, 16 A, 0.14 mm² ... 2.5 mm², application: Power

HC-EVO-B16PT-BWD-HH-M25ELC-AL - Connector set

1411489

<https://www.phoenixcontact.com/us/products/1411489>

HC-B-G-M25-EC-AL - Cable gland

1411446

<https://www.phoenixcontact.com/us/products/1411446>



EVO EMC cable gland with bayonet locking, B series, size M25, cable diameter: 11 ... 16 mm

HC-STA-B16-BWD-ELC-AL - Housing

1411327

<https://www.phoenixcontact.com/us/products/1411327>



HEAVYCON B16 panel mounting base, with double locking latch, with flat gasket, salt-water-resistant aluminum, conductive profile gasket

HC-EVO-B16PT-BWD-HH-M25ELC-AL - Connector set



1411489

<https://www.phoenixcontact.com/us/products/1411489>

HC-EVO-B16-HHFD-EL-AL - Housing

1411460

<https://www.phoenixcontact.com/us/products/1411460>



HEAVYCON EVO sleeve housing, EMC version, without powder coating, with bayonet flange for EVO screw connection, B16, for double locking latch, height: 88 mm, without EVO screw connection.

HC-EVO-B16PT-BWD-HH-M25ELC-AL - Connector set



1411489

<https://www.phoenixcontact.com/us/products/1411489>

Technical data

Product properties

Product type	Connector set
Housing type	Complete housing
Series	HC-B
Type	B16
Number of positions	16
Connection profile	16+PE
Contact numbering	1 - 16
No. of cable outlets	1
Seal present	yes
Protective cover	no
Cable outlet	straight

Insulation characteristics

Overvoltage category	III
Degree of pollution	3

Electrical properties

Rated voltage (III/3)	500 V
Rated surge voltage	6 kV
Rated current	16 A

Connection data

Connection method	Push-in connection
Connection technology	Push-in connection
Connection in acc. with standard	IEC / EN
Conductor cross-section	0.14 mm ² ... 2.5 mm ² (with ferrule) 0.14 mm ² ... 2.5 mm ² (with ferrule)
Connection cross section AWG	26 ... 14
Tightening torque	0.8 Nm ... 1.2 Nm (PE connection) 0.5 Nm ... 0.8 Nm (Mounting screws for mounting in the HEAVYCON housing)
Stripping length	8 mm ... 10 mm

Dimensions

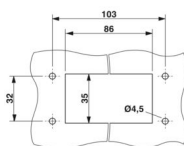
Dimensional drawing	
Width	53 mm
Height	118.5 mm

HC-EVO-B16PT-BWD-HH-M25ELC-AL - Connector set



1411489

<https://www.phoenixcontact.com/us/products/1411489>

Length	93.5 mm
Drill hole distance, horizontal	83 mm
Drill hole distance, vertical	32 mm

Installation dimensions

Width of the assembly cutout	35 mm
Length of the assembly cutout	86 mm

Material specifications

Material Housing	Die-cast aluminum, corrosion-resistant
Material Protective cover	PA
Flammability rating according to UL 94	V0
Seal material	NBR NBR
Contact material	Copper alloy
Contact surface material	Ag
Contact carrier material	PA
Locking latch material	PA

Cable/line

External cable diameter	11 mm ... 16 mm
-------------------------	-----------------

Mechanical properties

Mechanical data

Locking type	Latch
Insertion/withdrawal cycles	≥ 500

Environmental and real-life conditions

Ambient conditions

Degree of protection	IP66 IP67 IP66
Enclosure rating (NEMA)	4 (UL 50e) 4X (UL 50e) 12 (UL 50e)
Impact strength	IK09
Ambient temperature (operation)	-40 °C ... 100 °C

Mounting

Mounting type	Screw mounting
Assembly note	Coding also using the CP-HC (1686478) coding profiles. HC-B6.. / HC-B10..for two coding profiles. HC-B16../ HC-B24..for four coding profiles. Connectors may only be operated when there is no load/the power is switched off. Can be used for solid wires and stranded

HC-EVO-B16PT-BWD-HH-M25ELC-AL - Connector set



1411489

<https://www.phoenixcontact.com/us/products/1411489>

wires with ferrule.

HC-EVO-B16PT-BWD-HH-M25ELC-AL - Connector set



1411489

<https://www.phoenixcontact.com/us/products/1411489>

Drawings

Dimensional drawing

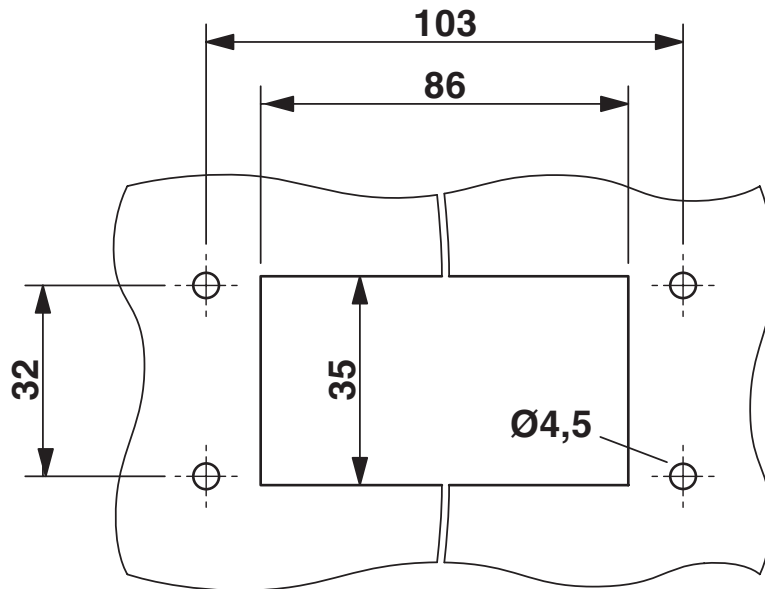

Mounting cutout

Dimensional drawing

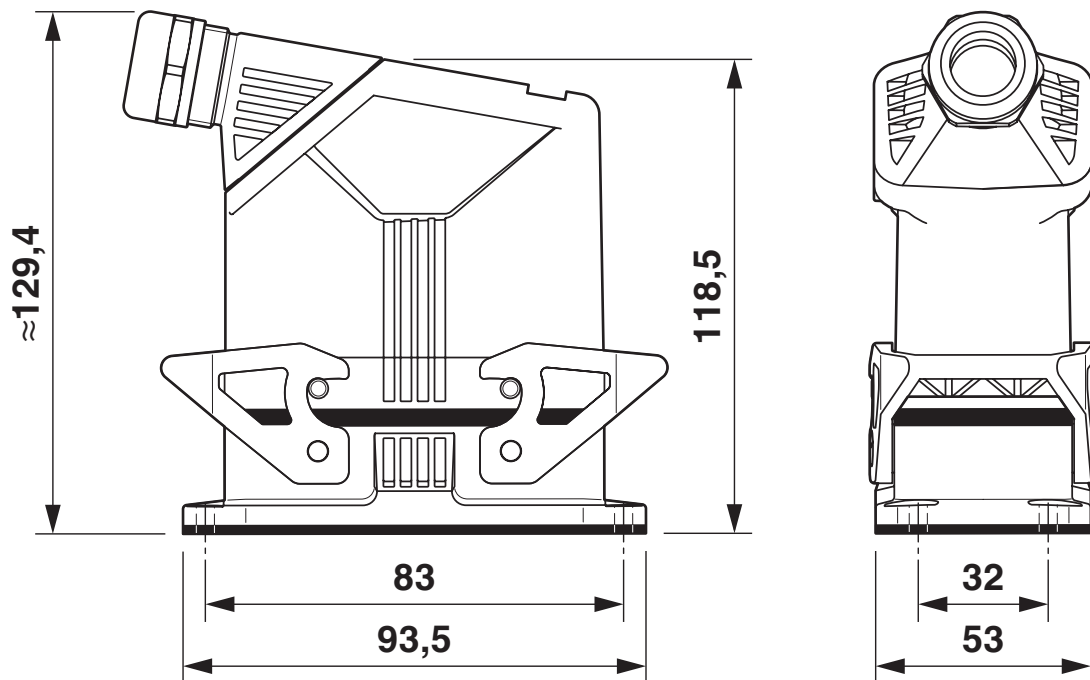

Dimensional drawing

HC-EVO-B16PT-BWD-HH-M25ELC-AL - Connector set

1411489

<https://www.phoenixcontact.com/us/products/1411489>

Schematic diagram

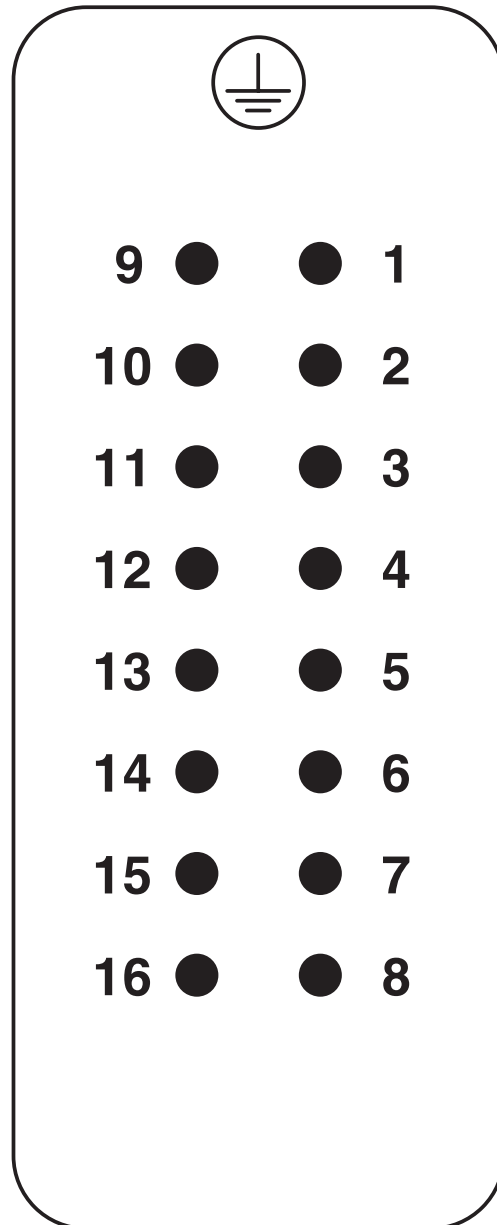

Pin assignment, connection side, pin

HC-EVO-B16PT-BWD-HH-M25ELC-AL - Connector set



1411489

<https://www.phoenixcontact.com/us/products/1411489>

Schematic diagram

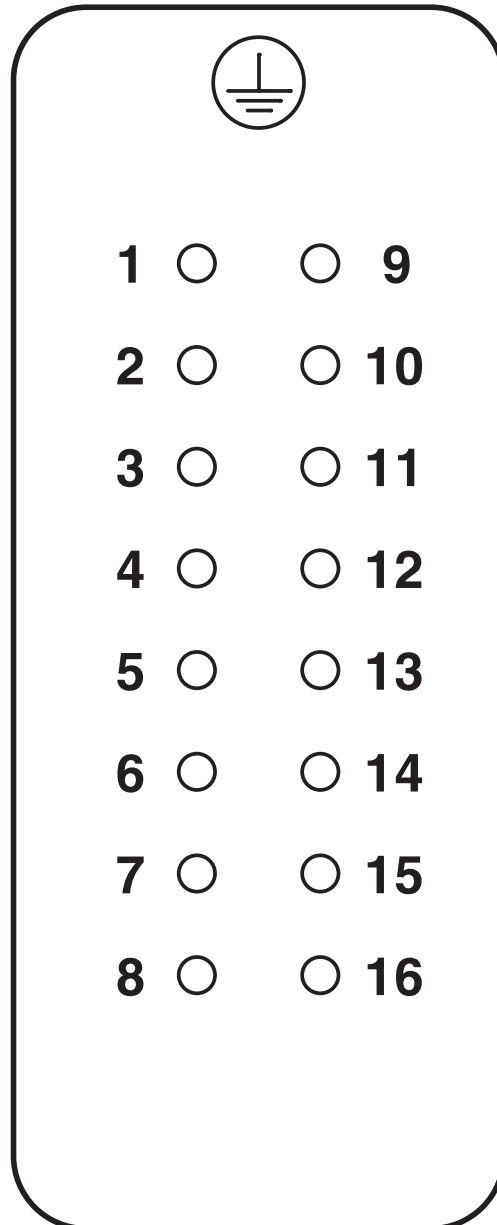

Pin assignment, connection side, socket

HC-EVO-B16PT-BWD-HH-M25ELC-AL - Connector set



1411489

<https://www.phoenixcontact.com/us/products/1411489>

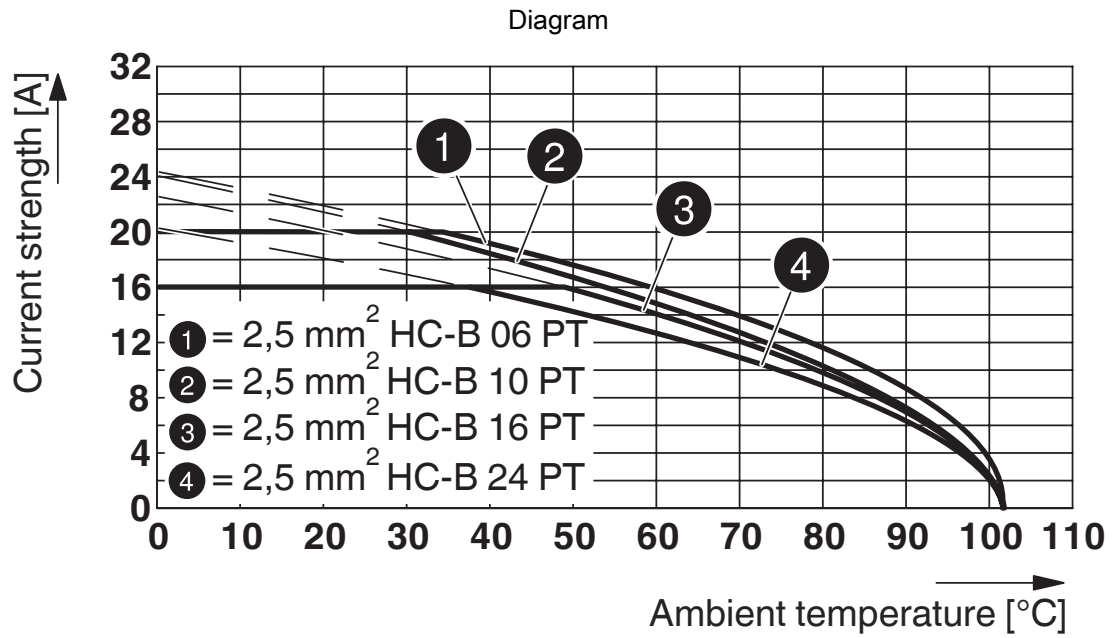

Derating diagram

HC-EVO-B16PT-BWD-HH-M25ELC-AL - Connector set



1411489

<https://www.phoenixcontact.com/us/products/1411489>

Approvals

To download certificates, visit the product detail page: <https://www.phoenixcontact.com/us/products/1411489>

DNV

Approval ID: TAE000037S



EAC

Approval ID: RU C-DE.AI30.B.01102

HC-EVO-B16PT-BWD-HH-M25ELC-AL - Connector set



1411489

<https://www.phoenixcontact.com/us/products/1411489>

Classifications

ECLASS

ECLASS-13.0	27440113
ECLASS-15.0	27440113

ETIM

ETIM 10.0	EC002636
-----------	----------

UNSPSC

UNSPSC 21.0	39121400
-------------	----------

HC-EVO-B16PT-BWD-HH-M25ELC-AL - Connector set



1411489

<https://www.phoenixcontact.com/us/products/1411489>

Environmental product compliance

EU RoHS

Fulfills EU RoHS substance requirements	Yes, No exemptions
---	--------------------

China RoHS

Environment friendly use period (EFUP)	EFUP-E
	No hazardous substances above the limits

EU REACH SVHC

REACH candidate substance (CAS No.)	No substance above 0.1 wt%
-------------------------------------	----------------------------

Phoenix Contact 2026 © - all rights reserved
<https://www.phoenixcontact.com>

Phoenix Contact USA
586 Fulling Mill Road
Middletown, PA 17057, United States
(+717) 944-1300
info@phoenixcon.com