

# G-INS-PG42-L68N-PNES-GY - Cable gland



1411149

<https://www.phoenixcontact.com/us/products/1411149>

Please be informed that the data shown in this PDF document is generated from our online catalog. Please find the complete data in the user documentation. Our general terms of use for downloads are valid.



Cable gland, material for screw connection: PA, application: Standard, external cable diameter 30 mm ... 38 mm, shielding: no, connecting thread: Pg42, color: silver-gray RAL 7001

## Your advantages

- Plastic material conforms to UL 746C f1

## Commercial data

Item number	1411149
Packing unit	1 pc
Minimum order quantity	1 pc
Sales key	BF68
Product key	AF7DCX
GTIN	4046356922852
Weight per piece (including packing)	89.9 g
Weight per piece (excluding packing)	89.9 g
Customs tariff number	39269097
Country of origin	TR

# G-INS-PG42-L68N-PNES-GY - Cable gland



1411149

<https://www.phoenixcontact.com/us/products/1411149>

## Technical data

### Mounting

Assembly note	1) Mount screw connection support in the housing using the correct torque 2) Insert cable 3) Tighten union nut using the correct torque
---------------	---

### Product properties

Product type	Cable screw gland
Application	Standard
No. of conductors	1
Manufacturer	BIMED
Manufacturer Designation	BS-09
Shielded	no

### Dimensions

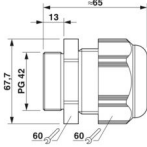
Dimensional drawing	
Length	65 mm
Length of the connecting thread	13 mm
Hole diameter	54.1 mm ... 54.4 mm
Wrench size, union nut	60 mm
Wrench size, support	60 mm
Hexagon angular dimension	67.7 mm
Thread type connection side	Pg42

### Connection data

Tightening torque	20 Nm $\pm$ 1 Nm (Cap nut)
	14 Nm (Support sleeve)

### Material specifications

Color	silver gray (RAL 7001)
Material Housing	PA (Housing)
Flammability rating according to UL 94	V2
Seal material Cable seal	CR
Material for screw connection	PA

### Cable/line

External cable diameter Cable 1	30 mm ... 38 mm
External cable diameter	30 mm ... 38 mm (for UL 514 B)
Halogen-free	no

# G-INS-PG42-L68N-PNES-GY - Cable gland



1411149

<https://www.phoenixcontact.com/us/products/1411149>

## Environmental and real-life conditions

### Ambient conditions

Degree of protection	IP66
	IP68 (5 bar / 0.5 h)
Enclosure rating (NEMA)	1
	4
	4X
	12
	13
Ambient temperature (operation)	-40 °C ... 100 °C (static)

# G-INS-PG42-L68N-PNES-GY - Cable gland



1411149

<https://www.phoenixcontact.com/us/products/1411149>

## Drawings

Dimensional drawing

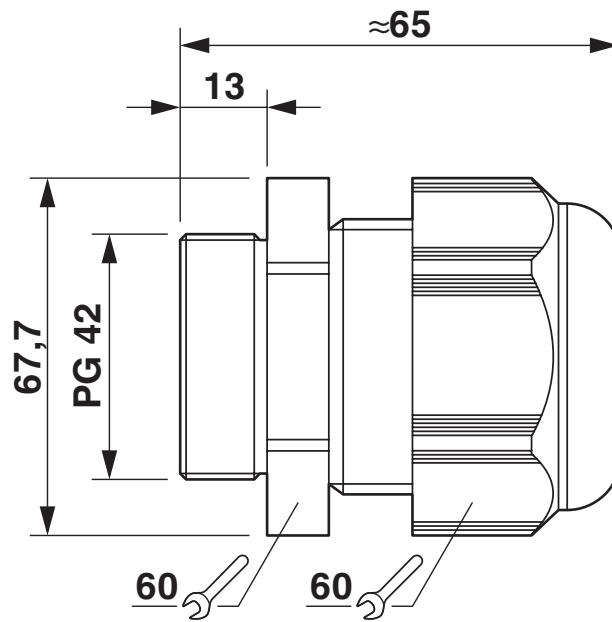

Dimensional drawing

# G-INS-PG42-L68N-PNES-GY - Cable gland



1411149

<https://www.phoenixcontact.com/us/products/1411149>

## Approvals

🔗 To download certificates, visit the product detail page: <https://www.phoenixcontact.com/us/products/1411149>

### **DNV**

Approval ID: TAE0003WX



### **CSA**

Approval ID: 115116



### **UL Listed**

Approval ID: E199260

# G-INS-PG42-L68N-PNES-GY - Cable gland



1411149

<https://www.phoenixcontact.com/us/products/1411149>

## Classifications

### ECLASS

ECLASS-13.0	27140801
ECLASS-15.0	27140801

### ETIM

ETIM 10.0	EC000441
-----------	----------

### UNSPSC

UNSPSC 21.0	39121300
-------------	----------

# G-INS-PG42-L68N-PNES-GY - Cable gland



1411149

<https://www.phoenixcontact.com/us/products/1411149>

## Environmental product compliance

### EU RoHS

Fulfills EU RoHS substance requirements	Yes, No exemptions
---	--------------------

### China RoHS

Environment friendly use period (EFUP)	EFUP-E
	No hazardous substances above the limits

### EU REACH SVHC

REACH candidate substance (CAS No.)	No substance above 0.1 wt%
-------------------------------------	----------------------------

### EF3.1 Climate Change

CO2e kg	0.782 kg CO2e
---------	---------------

Phoenix Contact 2026 © - all rights reserved  
<https://www.phoenixcontact.com>

Phoenix Contact USA  
586 Fulling Mill Road  
Middletown, PA 17057, United States  
(+717) 944-1300  
[info@phoenixcon.com](mailto:info@phoenixcon.com)