

G-INS-M20-S68N-PNES-GY - Cable gland



1411125

<https://www.phoenixcontact.com/us/products/1411125>

Please be informed that the data shown in this PDF document is generated from our online catalog. Please find the complete data in the user documentation. Our general terms of use for downloads are valid.



Cable gland, material for screw connection: PA, application: Standard, external cable diameter 6 mm ... 12 mm, shielding: no, connecting thread: M20 x 1.5, color: silver-gray RAL 7001

Your advantages

- Plastic material conforms to UL 746C f1

Commercial data

Item number	1411125
Packing unit	5 pc
Minimum order quantity	1 pc
Sales key	BF68
Product key	AF7DCX
GTIN	4046356922548
Weight per piece (including packing)	10.66 g
Weight per piece (excluding packing)	10 g
Customs tariff number	39269097
Country of origin	TR

G-INS-M20-S68N-PNES-GY - Cable gland



1411125

<https://www.phoenixcontact.com/us/products/1411125>

Technical data

Mounting

Assembly note	1) Mount screw connection support in the housing using the correct torque 2) Insert cable 3) Tighten union nut using the correct torque
---------------	---

Product properties

Product type	Cable screw gland
Application	Standard
No. of conductors	1
Manufacturer	BIMED
Manufacturer Designation	BM-02
Shielded	no
Execution of the strain relief	A

Characteristics

Category of shock impact	2
Design, Strain relief	A

Dimensions

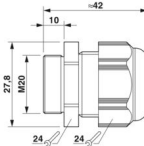
Dimensional drawing	
Length	42 mm
Length of the connecting thread	10 mm
Hole diameter	20.1 mm ... 20.2 mm
Wrench size, union nut	24 mm
Wrench size, support	24 mm
Hexagon angular dimension	27.8 mm
Thread type connection side	M20 x 1.5
Thread pitch	1.5 mm

Connection data

Tightening torque	4 Nm \pm 0.5 Nm (Cap nut)
	3.5 Nm (Support sleeve)

Material specifications

Color	silver gray (RAL 7001)
Material Housing	PA (Housing)
Flammability rating according to UL 94	V2
Seal material Cable seal	CR

G-INS-M20-S68N-PNES-GY - Cable gland



1411125

<https://www.phoenixcontact.com/us/products/1411125>

Material for screw connection	PA
-------------------------------	----

Cable/line

External cable diameter Cable 1	6 mm ... 12 mm
External cable diameter	6 mm ... 12 mm (for UL 514 B)
Halogen-free	no

Environmental and real-life conditions

Ambient conditions

Degree of protection	IP66
	IP68 (5 bar / 0.5 h)
Enclosure rating (NEMA)	1
	4
	4X
	12
	13
Ambient temperature (operation)	-40 °C ... 100 °C (static)

G-INS-M20-S68N-PNES-GY - Cable gland

1411125

<https://www.phoenixcontact.com/us/products/1411125>

Drawings

Dimensional drawing

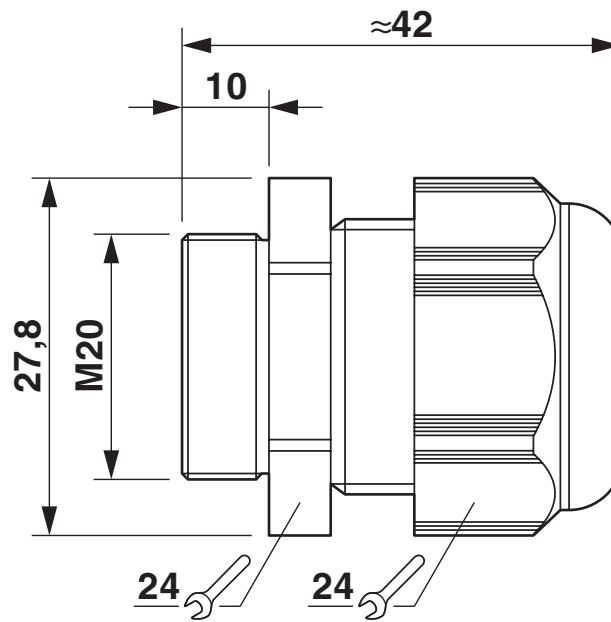

Dimensional drawing

G-INS-M20-S68N-PNES-GY - Cable gland



1411125

<https://www.phoenixcontact.com/us/products/1411125>

Approvals

To download certificates, visit the product detail page: <https://www.phoenixcontact.com/us/products/1411125>

DNV

Approval ID: TAE0003WX



CSA

Approval ID: 115116



VDE Zeichengenehmigung

Approval ID: 40024418



UL Listed

Approval ID: E199260

G-INS-M20-S68N-PNES-GY - Cable gland



1411125

<https://www.phoenixcontact.com/us/products/1411125>

Classifications

ECLASS

ECLASS-13.0	27140801
ECLASS-15.0	27140801

ETIM

ETIM 10.0	EC000441
-----------	----------

UNSPSC

UNSPSC 21.0	39121300
-------------	----------

G-INS-M20-S68N-PNES-GY - Cable gland



1411125

<https://www.phoenixcontact.com/us/products/1411125>

Environmental product compliance

EU RoHS

Fulfills EU RoHS substance requirements	Yes, No exemptions
---	--------------------

China RoHS

Environment friendly use period (EFUP)	EFUP-E
	No hazardous substances above the limits

EU REACH SVHC

REACH candidate substance (CAS No.)	No substance above 0.1 wt%
-------------------------------------	----------------------------

Phoenix Contact 2026 © - all rights reserved
<https://www.phoenixcontact.com>

Phoenix Contact USA
586 Fulling Mill Road
Middletown, PA 17057, United States
(+717) 944-1300
info@phoenixcon.com