

# HC-B 16-FL-MDI - Seal

1410945

<https://www.phoenixcontact.com/us/products/1410945>

Please be informed that the data shown in this PDF document is generated from our online catalog. Please find the complete data in the user documentation. Our general terms of use for downloads are valid.

Flange seal, for HEAVYCON type B16 panel mounting base, self-adhesive, foam rubber made from cellular rubber, color: black



## Commercial data

|                                      |                                |
|--------------------------------------|--------------------------------|
| Item number                          | 1410945                        |
| Packing unit                         | 1 pc                           |
| Note                                 | Made to order (non-returnable) |
| Sales key                            | BF66                           |
| Product key                          | AF7AAZ                         |
| GTIN                                 | 4046356893459                  |
| Weight per piece (including packing) | 1.46 g                         |
| Weight per piece (excluding packing) | 1.46 g                         |
| Customs tariff number                | 40169300                       |
| Country of origin                    | DE                             |

# HC-B 16-FL-MDI - Seal

1410945

<https://www.phoenixcontact.com/us/products/1410945>



## Technical data

### Product properties

|              |      |
|--------------|------|
| Product type | Seal |
|--------------|------|

### Dimensions

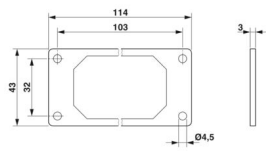
|                     |  |
|---------------------|--|
| Dimensional drawing |  |
| Height              | 3 mm   |

### Material specifications

|          |                 |
|----------|-----------------|
| Material | Cellular rubber |
|----------|-----------------|

### Environmental and real-life conditions

#### Ambient conditions

|                                 |                   |
|---------------------------------|-------------------|
| Ambient temperature (operation) | -40 °C ... 125 °C |
|---------------------------------|-------------------|

### Mounting

|               |                            |
|---------------|----------------------------|
| Assembly note | Not for HC-...EMC housings |
|---------------|----------------------------|

# HC-B 16-FL-MDI - Seal

1410945

<https://www.phoenixcontact.com/us/products/1410945>



## Drawings

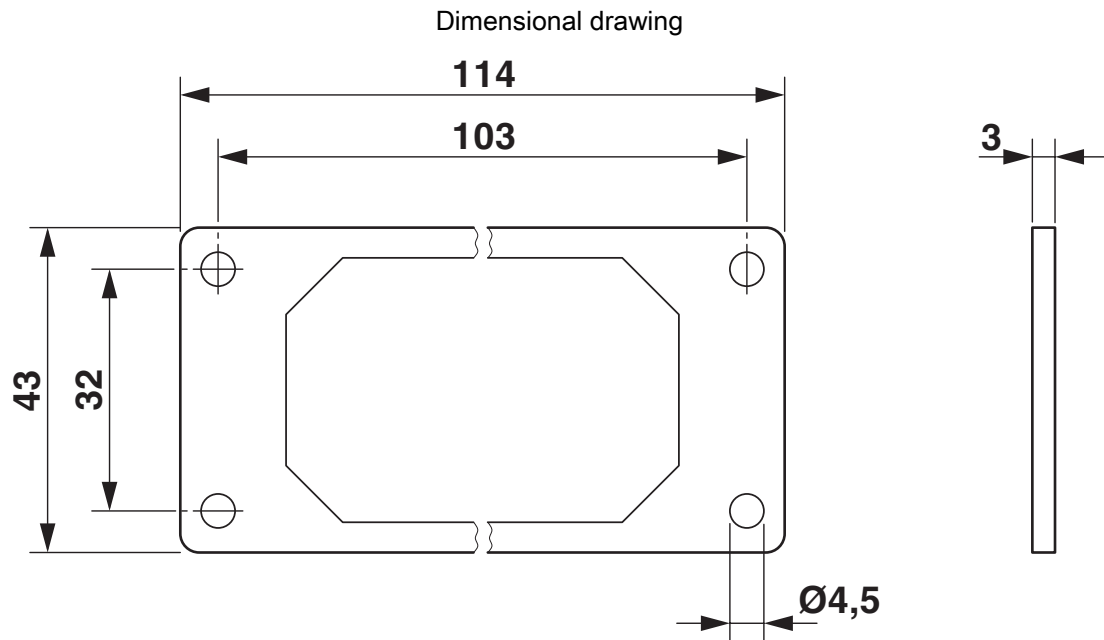

Dimensional drawing

# HC-B 16-FL-MDI - Seal



1410945

<https://www.phoenixcontact.com/us/products/1410945>

## Environmental product compliance

### EU RoHS

|   |                    |
|---|--------------------|
| Fulfills EU RoHS substance requirements | Yes, No exemptions |
|---|--------------------|

### China RoHS

|  |  |
|--|--|
| Environment friendly use period (EFUP) | EFUP-E                                   |
|  | No hazardous substances above the limits |

### EU REACH SVHC

|                                     |                            |
|-------------------------------------|----------------------------|
| REACH candidate substance (CAS No.) | No substance above 0.1 wt% |
|-------------------------------------|----------------------------|

Phoenix Contact 2026 © - all rights reserved  
<https://www.phoenixcontact.com>

Phoenix Contact USA  
586 Fulling Mill Road  
Middletown, PA 17057, United States  
(+717) 944-1300  
[info@phoenixcon.com](mailto:info@phoenixcon.com)