

HC-B 6-FL-MDI - Seal

1410929

<https://www.phoenixcontact.com/us/products/1410929>

Please be informed that the data shown in this PDF document is generated from our online catalog. Please find the complete data in the user documentation. Our general terms of use for downloads are valid.

Flange seal, for HEAVYCON type B6 panel mounting base, self-adhesive, foam rubber made from cellular rubber, color: black



Commercial data

Item number	1410929
Packing unit	1 pc
Note	Made to order (non-returnable)
Sales key	BF66
Product key	AF7AAZ
GTIN	4046356893435
Weight per piece (including packing)	1.3 g
Weight per piece (excluding packing)	1.3 g
Customs tariff number	40169300
Country of origin	DE

HC-B 6-FL-MDI - Seal

1410929

<https://www.phoenixcontact.com/us/products/1410929>



Technical data

Product properties

Product type	Seal
--------------	------

Dimensions

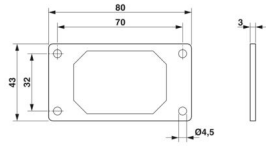
Dimensional drawing	
Height	3 mm

Material specifications

Material	Cellular rubber
----------	-----------------

Environmental and real-life conditions

Ambient conditions

Ambient temperature (operation)	-40 °C ... 125 °C
---------------------------------	-------------------

Mounting

Assembly note	Not for HC-...EMC housings
---------------	----------------------------

HC-B 6-FL-MDI - Seal

1410929

<https://www.phoenixcontact.com/us/products/1410929>



Drawings

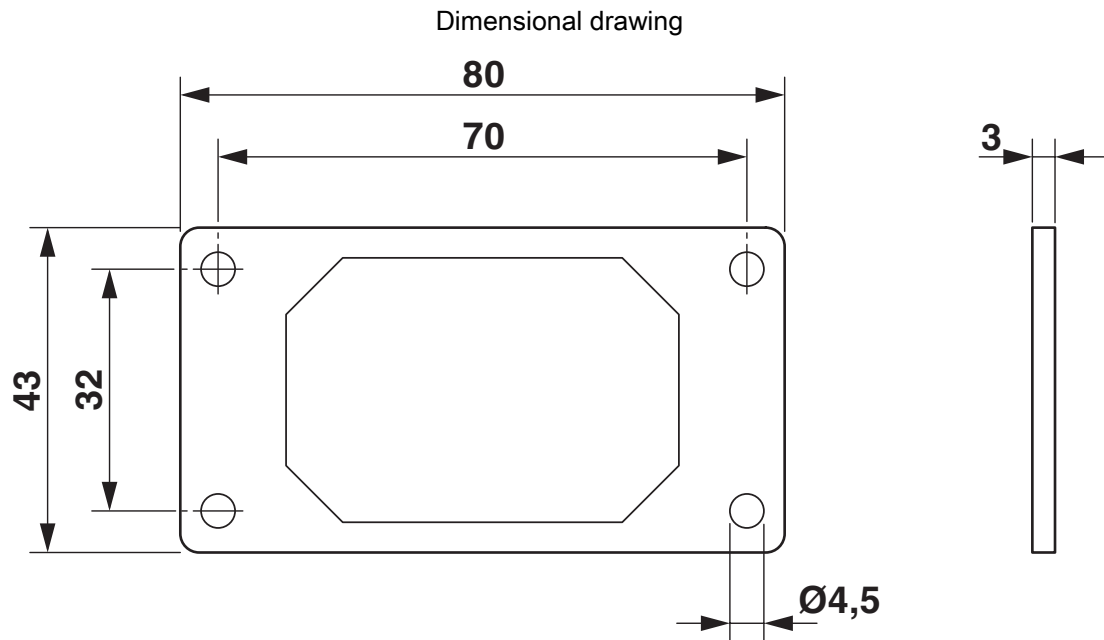

Dimensional drawing

HC-B 6-FL-MDI - Seal



1410929

<https://www.phoenixcontact.com/us/products/1410929>

Environmental product compliance

EU RoHS

Fulfills EU RoHS substance requirements	Yes, No exemptions
---	--------------------

China RoHS

Environment friendly use period (EFUP)	EFUP-E
	No hazardous substances above the limits

EU REACH SVHC

REACH candidate substance (CAS No.)	No substance above 0.1 wt%
-------------------------------------	----------------------------

Phoenix Contact 2026 © - all rights reserved
<https://www.phoenixcontact.com>

Phoenix Contact USA
586 Fulling Mill Road
Middletown, PA 17057, United States
(+717) 944-1300
info@phoenixcon.com