

EV-TAM3PC-1AC32A-4,0M6,0ESBK00 - AC charging cable



1410090

<https://www.phoenixcontact.com/us/products/1410090>

Please be informed that the data shown in this PDF document is generated from our online catalog. Please find the complete data in the user documentation. Our general terms of use for downloads are valid.

CHARX connect, Type 1, Type 2, cable: 4 m, straight, IEC 62196-2, SAE J1772, Mobile AC charging cable with vehicle connector and infrastructure plug, with protective cap



Product description

Mobile AC charging cable with vehicle charging connector and infrastructure charging plug for charging electric vehicles (EV) with alternating current (AC) via type 1 vehicle charging inlets, compatible with type 2 infrastructure charging sockets at charging stations for e-mobility (EVSE)

Your advantages

- Consistent design of all Phoenix Contact Vehicle Connectors and Infrastructure Plugs
- Silver-plated surface of the power and signal contacts
- Developed and produced in accordance with the IATF 16949 automotive standard and ISO 9001
- Convenient handling, thanks to the ergonomic handle and additional, rubber grip components

Commercial data

Item number	1410090
Packing unit	1 pc
Minimum order quantity	1 pc
Product key	XWBAEE
GTIN	4046356889681
Weight per piece (including packing)	2.267 kg
Weight per piece (excluding packing)	2.204 kg
Country of origin	DE

EV-TAM3PC-1AC32A-4,0M6,0ESBK00 - AC charging cable



1410090

<https://www.phoenixcontact.com/us/products/1410090>

Technical data

Product properties

Product type	AC charging cable
Product family	CHARX connect
Charging standard	Type 1
	Type 2
Charging mode	Mode 3, Case B

Electrical properties

Charging power and current (AC charging, 1-phase)

Type of charging current	AC single-phase
Charging current	32 A AC (1-phase)
Charging power	8 kW
Rated voltage	250 V

Cable/line

Cable length	4 m
Wiring standards/regulations	prEN 50620/DIN EN 50620
Wiring certifications	VDE
Cable weight	max. 305.00 kg/km
Cable type	Class 5
Cable type	straight
Cable structure	3 x 6.0 mm ² + 1 x 0.5 mm ²
External cable diameter	12.80 mm ±0.4 mm
Outer sheath, material	TPE-U
Cable resistance	≤ 0.0033 Ω/m (based on a power core, at an ambient temperature of 20°C)
Bending radius	min. 96 mm (7.5x diameter)
Cable length	4 m
External cable diameter	12.80 mm ±0.4 mm
Cable type	Class 5
Wiring certifications	VDE
Wiring standards/regulations	prEN 50620/DIN EN 50620
Cable resistance	≤ 0.0033 Ω/m (based on a power core, at an ambient temperature of 20°C)

Standards and regulations

Standards

Standards/regulations	IEC 62196-2
	SAE J1772

EV-TAM3PC-1AC32A-4,0M6,0ESBK00 - AC charging cable



1410090

<https://www.phoenixcontact.com/us/products/1410090>

Drawings

Dimensional drawing

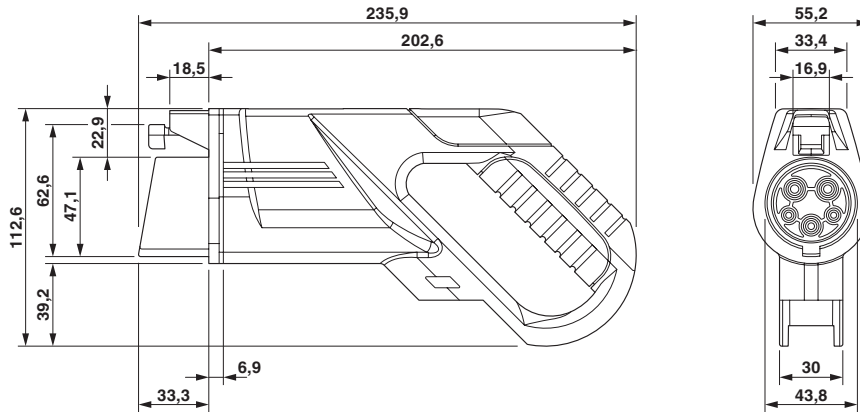

Vehicle connector

Dimensional drawing

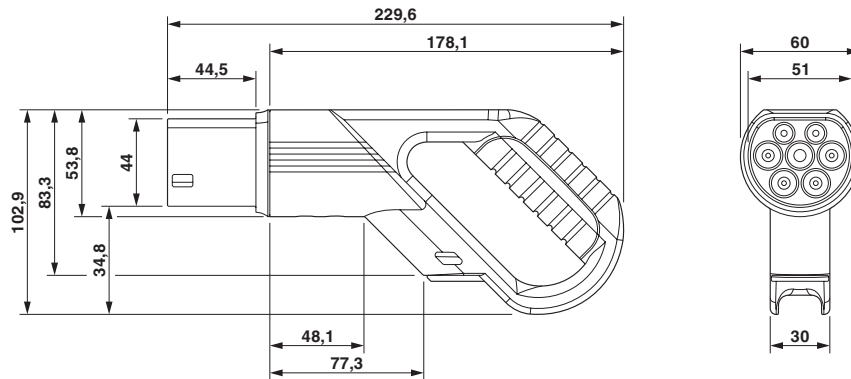

Infrastructure plug

EV-TAM3PC-1AC32A-4,0M6,0ESBK00 - AC charging cable

1410090

<https://www.phoenixcontact.com/us/products/1410090>



Pin assignment of the Vehicle Connector

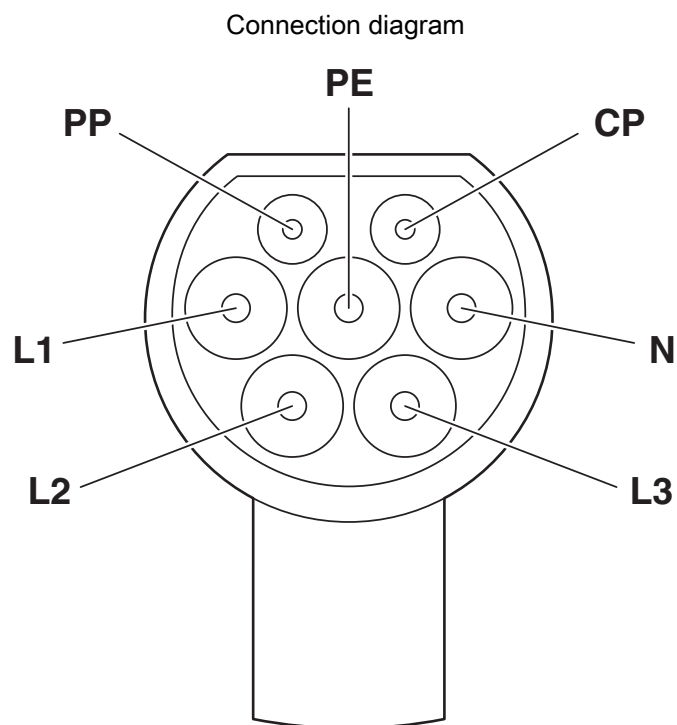

Pin assignment of Infrastructure Plug

EV-TAM3PC-1AC32A-4,0M6,0ESBK00 - AC charging cable

1410090

<https://www.phoenixcontact.com/us/products/1410090>

Schematic diagram

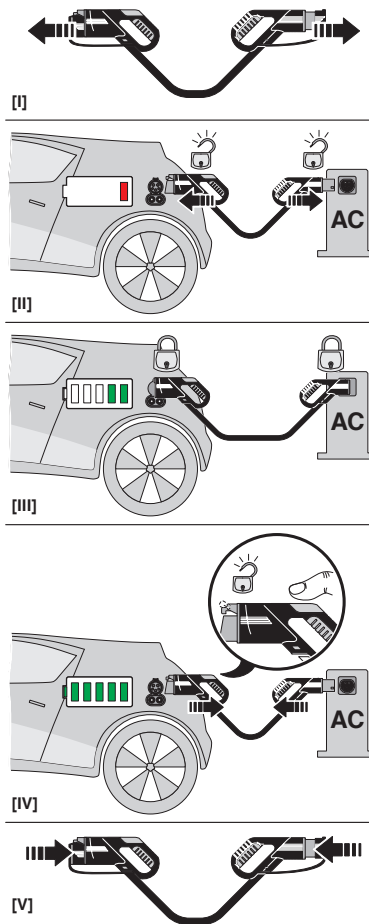

Operating instructions

EV-TAM3PC-1AC32A-4,0M6,0ESBK00 - AC charging cable



1410090

<https://www.phoenixcontact.com/us/products/1410090>

Environmental product compliance

China RoHS

Environment friendly use period (EFUP)	EFUP-10 An article-related China RoHS declaration table can be found in the download area for the respective article under "Manufacturer declaration". For all articles with EFUP-E, no China RoHS declaration table issued and required.
--	--

EU REACH SVHC

REACH candidate substance (CAS No.)	No substance above 0.1 wt%
-------------------------------------	----------------------------

Phoenix Contact 2026 © - all rights reserved
<https://www.phoenixcontact.com>

Phoenix Contact USA
586 Fulling Mill Road
Middletown, PA 17057, United States
(+717) 944-1300
info@phoenixcon.com