

HC-B 10-TMS-EEE-PR-DI - Profile gasket



1409804

<https://www.phoenixcontact.com/us/products/1409804>

Please be informed that the data shown in this PDF document is generated from our online catalog. Please find the complete data in the user documentation. Our general terms of use for downloads are valid.

Profile gasket for sleeve housing type B10.....EEE



Commercial data

Item number	1409804
Packing unit	10 pc
Minimum order quantity	10 pc
Sales key	BF66
Product key	AF7APZ
GTIN	4046356750912
Weight per piece (including packing)	5.26 g
Weight per piece (excluding packing)	3.1 g
Customs tariff number	40169300
Country of origin	DE

HC-B 10-TMS-EEE-PR-DI - Profile gasket



1409804

<https://www.phoenixcontact.com/us/products/1409804>

Technical data

Product properties

Product type	Seal
Type	B10

Dimensions

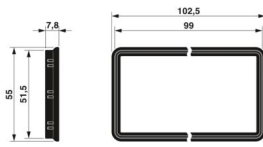
Dimensional drawing	
Width	55 mm
Height	7.8 mm
Length	102.5 mm

Material specifications

Material	NBR, conductive
----------	-----------------

Environmental and real-life conditions

Ambient conditions

Ambient temperature (operation)	-40 °C ... 125 °C
---------------------------------	-------------------

HC-B 10-TMS-EEE-PR-DI - Profile gasket



1409804

<https://www.phoenixcontact.com/us/products/1409804>

Drawings

Dimensional drawing

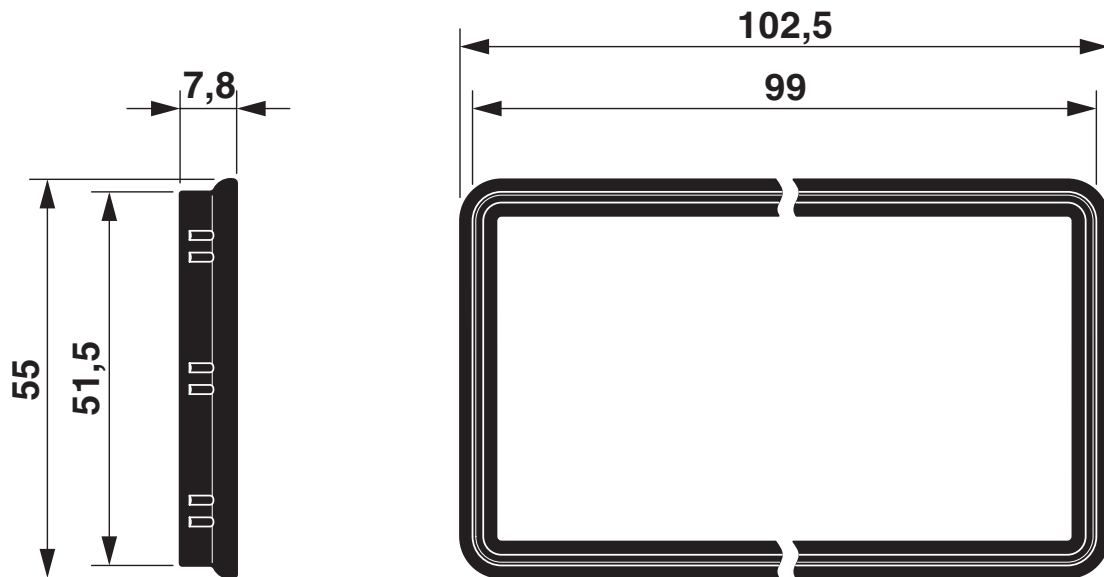

Dimensional drawing

HC-B 10-TMS-EEE-PR-DI - Profile gasket



1409804

<https://www.phoenixcontact.com/us/products/1409804>

Approvals

To download certificates, visit the product detail page: <https://www.phoenixcontact.com/us/products/1409804>



EAC

Approval ID: RU C-DE.AI30.B.01102

HC-B 10-TMS-EEE-PR-DI - Profile gasket



1409804

<https://www.phoenixcontact.com/us/products/1409804>

Classifications

ECLASS

ECLASS-13.0	23071590
ECLASS-15.0	27440292

ETIM

ETIM 10.0	EC002943
-----------	----------

UNSPSC

UNSPSC 21.0	31401600
-------------	----------

HC-B 10-TMS-EEE-PR-DI - Profile gasket



1409804

<https://www.phoenixcontact.com/us/products/1409804>

Environmental product compliance

EU RoHS

Fulfills EU RoHS substance requirements	Yes, No exemptions
---	--------------------

China RoHS

Environment friendly use period (EFUP)	EFUP-E
	No hazardous substances above the limits

EU REACH SVHC

REACH candidate substance (CAS No.)	No substance above 0.1 wt%
-------------------------------------	----------------------------

Phoenix Contact 2026 © - all rights reserved
<https://www.phoenixcontact.com>

Phoenix Contact USA
586 Fulling Mill Road
Middletown, PA 17057, United States
(+717) 944-1300
info@phoenixcon.com