

HC-B06-BC-HI-PLBK - Protective cover



1407692

<https://www.phoenixcontact.com/us/products/1407692>

Please be informed that the data shown in this PDF document is generated from our online catalog. Please find the complete data in the user documentation. Our general terms of use for downloads are valid.

Protective cover B6, for single locking latch, protective cover material: PC, height: 19 mm, seal: no



Commercial data

Item number	1407692
Packing unit	1 pc
Minimum order quantity	1 pc
Sales key	BF66
Product key	AF7AZC
GTIN	4046356776776
Weight per piece (including packing)	35 g
Weight per piece (excluding packing)	30.8 g
Customs tariff number	85389099
Country of origin	PL

HC-B06-BC-HI-PLBK - Protective cover

1407692

<https://www.phoenixcontact.com/us/products/1407692>

Technical data

Product properties

Product type	Protective cover
Housing type	Protective cover
Type	B6
Retaining cord present	no
Seal present	no

Dimensions

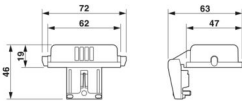
Dimensional drawing	
Width	47 mm
Height	19 mm
Length	62 mm

Material specifications

Material Protective cover	PC
Flammability rating according to UL 94	V0
Material, protective cover	PC

Environmental and real-life conditions

Ambient conditions

Degree of protection	IP65
	IP66
Ambient temperature (operation)	-20 °C ... 100 °C

HC-B06-BC-HI-PLBK - Protective cover



1407692

<https://www.phoenixcontact.com/us/products/1407692>

Drawings

Dimensional drawing

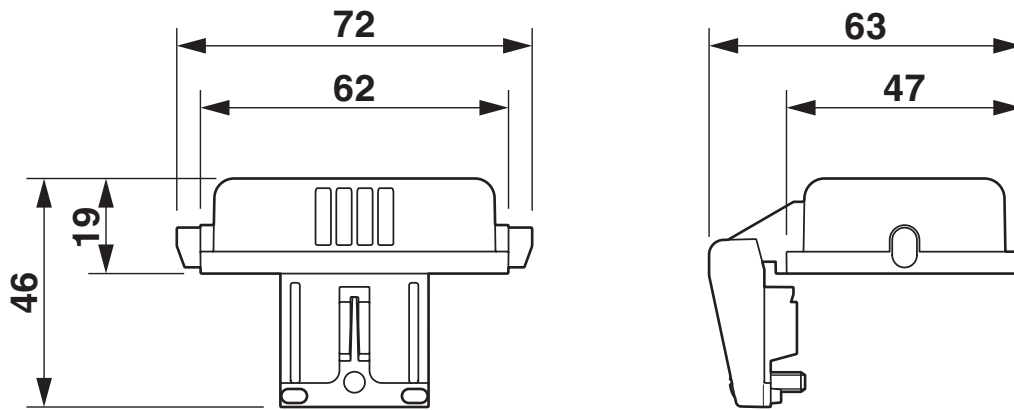

Dimensional drawing

HC-B06-BC-HI-PLBK - Protective cover



1407692

<https://www.phoenixcontact.com/us/products/1407692>

Approvals

To download certificates, visit the product detail page: <https://www.phoenixcontact.com/us/products/1407692>



EAC

Approval ID: RU C-DE.AI30.B.01102

HC-B06-BC-HI-PLBK - Protective cover



1407692

<https://www.phoenixcontact.com/us/products/1407692>

Classifications

ECLASS

ECLASS-13.0	27440208
ECLASS-15.0	27440208

ETIM

ETIM 10.0	EC002314
-----------	----------

UNSPSC

UNSPSC 21.0	39121400
-------------	----------

HC-B06-BC-HI-PLBK - Protective cover



1407692

<https://www.phoenixcontact.com/us/products/1407692>

Environmental product compliance

EU RoHS

Fulfills EU RoHS substance requirements	Yes, No exemptions
---	--------------------

China RoHS

Environment friendly use period (EFUP)	EFUP-E
	No hazardous substances above the limits

EU REACH SVHC

REACH candidate substance (CAS No.)	No substance above 0.1 wt%
-------------------------------------	----------------------------

EF3.1 Climate Change

CO2e kg	0.467 kg CO2e
---------	---------------

Phoenix Contact 2026 © - all rights reserved
<https://www.phoenixcontact.com>

Phoenix Contact USA
586 Fulling Mill Road
Middletown, PA 17057, United States
(+717) 944-1300
info@phoenixcon.com