

# NBC-M12MSD/ 2,0-93E/R4AC US - Network cable



1406127

<https://www.phoenixcontact.com/us/products/1406127>

Please be informed that the data shown in this PDF document is generated from our online catalog. Please find the complete data in the user documentation. Our general terms of use for downloads are valid.

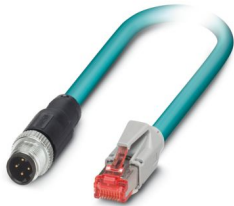

Network cable, Ethernet CAT5 (100 Mbps), 4-position, PUR halogen-free, water blue RAL 5021, shielded, Plug straight M12, coding: D / IP67, on Plug straight RJ45 / IP20, cable length: 2 m

## Commercial data

Item number	1406127
Packing unit	1 pc
Minimum order quantity	1 pc
Note	Made to order (non-returnable)
Sales key	BF15
Product key	AF1IHA
GTIN	4046356799225
Weight per piece (including packing)	103.72 g
Weight per piece (excluding packing)	101.2 g
Customs tariff number	85444290
Country of origin	US

1406127

<https://www.phoenixcontact.com/us/products/1406127>

## Technical data

### Product properties

Product type	Data cable preassembled
Application	Standard, U.S. cables
Number of positions	4
Shielded	yes
Coding	D

### Interfaces

Bus system	Ethernet
Signal type/category	Ethernet CAT5 (IEC 11801), 100 Mbps

### Signaling

Status display	no
Status display present	no

### Electrical properties

Nominal voltage $U_N$	48 V AC
	60 V DC
Nominal current $I_N$	1 A
Transmission medium	Copper
Transmission speed	100 Mbps
Transmission characteristics (category)	CAT5 (IEC 11801:2002)

### Material specifications

Seal material	NBR
Material of grip body	TPU, hardly inflammable, self-extinguishing
Contact material	CuZn
Contact surface material	Ni/Au
Contact carrier material	TPU GF

### Connector

#### Connection 1

Type	Plug straight M12 / IP67
Coding type	D (Data)
Material	CuSn (Contact)
	Ni/Au (Contact surface)
	TPU GF (Contact carrier)
	TPU, hardly inflammable, self-extinguishing (Grip body)
	Zinc die-cast, nickel-plated (Screw connection)
Degree of protection	IP67

#### Connection 2

# NBC-M12MSD/ 2,0-93E/R4AC US - Network cable



1406127

<https://www.phoenixcontact.com/us/products/1406127>

Type	Plug straight RJ45 / IP20
Material	CuSn (Contact)
	Ni/Au (Contact surface)
	PA (Contact carrier)
	PA (Housing)
Degree of protection	IP20

## Cable/line

Cable length	2 m
--------------	-----

### Ethernet flexible CAT5, 2-pair [93E]

Dimensional drawing	
Cable weight	42 kg/km
UL AWM Style	20963 (80°C/30 V)
Wiring standards/regulations	Electrical requirements EN 50288-2-2
Number of positions	4
Shielded	yes
Cable type	Ethernet flexible CAT5, 2-pair [93E]
Conductor structure	2x2xAWG26/7, SF/UTP
Signal runtime	5.3 ns/m
Conductor structure signal line	7x 0.16 mm
AWG signal line	26
Conductor cross-section	2x 2x 0.14 mm <sup>2</sup>
Wire diameter incl. insulation	0.98 mm
External cable diameter	6.40 mm ±0.2 mm
Outer sheath, material	PUR
External sheath, color	water blue RAL 5021
Conductor material	Bare Cu litz wires
Material wire insulation	Foamed PE
Single wire, color	white/orange-orange, white/green-green
Thickness, outer sheath	1.20 mm
Twisted pairs	2 cores to the pair
Overall twist	Two pairs with two fillers to the core
Optical shield covering	70 %
Insulation resistance	≥ 500 MΩ*km
Coupling resistance	≤ 100.00 mΩ/m (at 10 MHz)
Loop resistance	≤ 290.00 Ω/km

1406127

<https://www.phoenixcontact.com/us/products/1406127>

Wave impedance	100 $\Omega$ $\pm$ 5 $\Omega$ (at 100 MHz)
Cable capacity	approx. 45 nF/km (at 1 kHz)
Nominal voltage, cable	$\leq$ 100 V (Peak value, not for high-power applications)
Test voltage Core/Core	700 V (50 Hz, 1 min.)
Test voltage Core/Shield	700.00 V (50 Hz, 1 min.)
Current carrying capacity of cable	2.00 A (according to DIN VDE 0891-1)
Minimum bending radius, fixed installation	4 x D
Minimum bending radius, flexible installation	8 x D
Smallest bending radius, fixed installation	26 mm
Smallest bending radius, movable installation	52 mm
Tensile strength	$\leq$ 80 N
Near end crosstalk attenuation (NEXT)	65.3 dB (with 1 MHz)
	56.3 dB (at 4 MHz)
	50.3 dB (at 10 MHz)
	47.2 dB (at 16 MHz)
	45.8 dB (at 20 MHz)
	42.9 dB (at 31.25 MHz)
	38.4 dB (at 62.5 MHz)
	35.3 dB (at 100 MHz)
Power-summated near end crosstalk attenuation (PSNEXT)	62.3 dB (with 1 MHz)
	53.3 dB (at 4 MHz)
	47.3 dB (at 10 MHz)
	44.2 dB (at 16 MHz)
	42.8 dB (at 20 MHz)
	39.9 dB (at 31.25 MHz)
	35.4 dB (at 62.5 MHz)
	32.3 dB (at 100 MHz)
Return attenuation (RL)	23 dB (at 4 MHz)
	24.1 dB (at 8 MHz)
	25 dB (at 10 MHz)
	25 dB (at 16 MHz)
	25 dB (at 20 MHz)
	23.6 dB (at 31.25 MHz)
	21.5 dB (at 62.5 MHz)
	20.1 dB (at 100 MHz)
Shield attenuation	3.2 dB (with 1 MHz)
	6 dB (at 4 MHz)
	9.5 dB (at 10 MHz)
	12.1 dB (at 16 MHz)
	13.6 dB (at 20 MHz)
	17.1 dB (at 31.25 MHz)
	24.8 dB (at 62.5 MHz)
32 dB (at 100 MHz)	
Halogen-free	according to IEC 60754-1

1406127

<https://www.phoenixcontact.com/us/products/1406127>

Flame resistance	according to IEC 60332-1-2
	in acc. to UL VW1
	in accordance with UN ECE-R 118.03
Resistance to oil	in accordance with EN 60811-2-1
Ambient temperature (operation)	-40 °C ... 80 °C (cable, fixed installation)
	-20 °C ... 80 °C (Cable, flexible installation)
Ambient temperature (installation)	-20 °C ... 80 °C

### Environmental and real-life conditions

#### Ambient conditions

Degree of protection	IP65 (M12 connector)
	IP67 (M12 connector)
	IP20 (RJ45 connector)
	IP67/IP20
Ambient temperature (operation) (male connector/female connector)	-25 °C ... 85 °C (M12 connector)
	-25 °C ... 60 °C (RJ45 connector)

### Standards and regulations

#### M12

Standard designation	M12 connector
Standards/specifications	IEC 61076-2-101

Drawings

Dimensional drawing



Plug, M12 x 1, straight, shielded

Dimensional drawing



RJ45 connector, IP20

1406127

<https://www.phoenixcontact.com/us/products/1406127>

Schematic diagram



Pin assignment M12 male connector, 4-pos., D-coded, male side

Schematic diagram

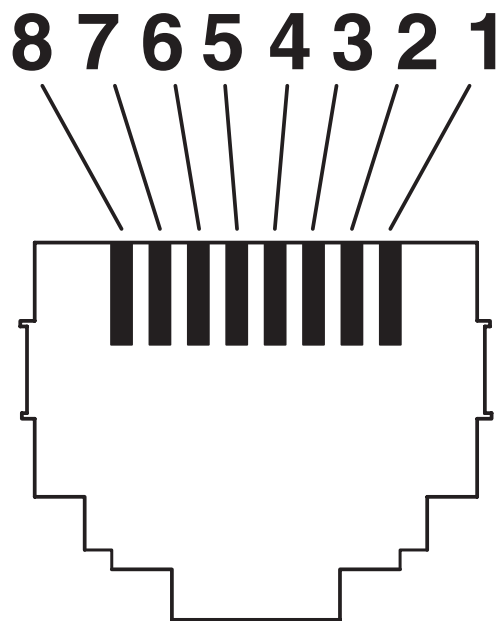

Connector pin assignment plug RJ45

1406127

<https://www.phoenixcontact.com/us/products/1406127>

Circuit diagram



Contact assignment of the M12 and RJ45 plug

1406127

<https://www.phoenixcontact.com/us/products/1406127>

## Approvals

To download certificates, visit the product detail page: <https://www.phoenixcontact.com/us/products/1406127>

 <b>UL Listed</b> Approval ID: FILE E 335024				
	Nominal voltage $U_N$	Nominal current $I_N$	Cross section AWG	Cross section $mm^2$
keine				
	30 V	0.5 A	-	-

 <b>EAC-RoHS</b> Approval ID: RU D-DE.HB35.B.00387				
--	--	--	--	--

 <b>cUL Listed</b> Approval ID: FILE E 335024				
	Nominal voltage $U_N$	Nominal current $I_N$	Cross section AWG	Cross section $mm^2$
keine				
	30 V	0.5 A	-	-

1406127

<https://www.phoenixcontact.com/us/products/1406127>

## Classifications

### ECLASS

ECLASS-13.0	27060307
ECLASS-15.0	27060307

### UNSPSC

UNSPSC 21.0	26121600
-------------	----------

1406127

<https://www.phoenixcontact.com/us/products/1406127>

## Environmental product compliance

### EU RoHS

Fulfills EU RoHS substance requirements	Yes, No exemptions
---	--------------------

### China RoHS

Environment friendly use period (EFUP)	EFUP-50
	An article-related China RoHS declaration table can be found in the download area for the respective article under "Manufacturer declaration". For all articles with EFUP-E, no China RoHS declaration table issued and required.

### EU REACH SVHC

REACH candidate substance (CAS No.)	No substance above 0.1 wt%
-------------------------------------	----------------------------

Phoenix Contact 2026 © - all rights reserved

<https://www.phoenixcontact.com>

Phoenix Contact USA  
586 Fulling Mill Road  
Middletown, PA 17057, United States  
(+717) 944-1300  
[info@phoenixcon.com](mailto:info@phoenixcon.com)