

SAC-4P-M12MR/ 0,5-542/M8FRSHBK - Sensor/actuator cable



1406000

<https://www.phoenixcontact.com/us/products/1406000>

Please be informed that the data shown in this PDF document is generated from our online catalog. Please find the complete data in the user documentation. Our general terms of use for downloads are valid.



Sensor/actuator cable, 4-position, PVC, yellow, shielded, Plug angled M12, coding: A, on Socket angled M8, cable length: 0.5 m

Commercial data

Item number	1406000
Packing unit	1 pc
Minimum order quantity	1 pc
Note	Made to order (non-returnable)
Sales key	BF13
Product key	AF1IDB
GTIN	4046356800297
Weight per piece (including packing)	22.22 g
Weight per piece (excluding packing)	22.22 g
Customs tariff number	85444290
Country of origin	US

SAC-4P-M12MR/ 0,5-542/M8FRSHBK - Sensor/actuator cable



1406000

<https://www.phoenixcontact.com/us/products/1406000>

Technical data

Product properties

Product type	Sensor/actuator cable
Application	Standard, U.S. cables
Number of positions	4
No. of cable outlets	1
Shielded	yes
Coding	A

Insulation characteristics

Overvoltage category	II
Degree of pollution	3

Material specifications

Flammability rating according to UL 94	HB
Seal material	NBR
Material of grip body	TPU, hardly inflammable, self-extinguishing
Contact material	CuSn
Contact surface material	Ni/Au
Contact carrier material	TPU GF
Material for screw connection	Zinc die-cast, nickel-plated
Outer sheath, material	PVC

Electrical properties

Insulation resistance	$\geq 100 \text{ M}\Omega$
Nominal voltage U_N	48 V AC
	60 V DC
Nominal current I_N	4 A

Mechanical properties

Mechanical data

Insertion/withdrawal cycles	≥ 100
-----------------------------	------------

Signaling

Status display	no
Status display present	no

Connection data

Conductor connection

Tightening torque	0.4 Nm (M12 connector)
	0.2 Nm (M8 connectors)

SAC-4P-M12MR/ 0,5-542/M8FRSHBK - Sensor/actuator cable



1406000

<https://www.phoenixcontact.com/us/products/1406000>

Connector

Connection 1

Type	Plug angled M12
Number of positions	4
Coding type	A

Connection 2

Type	Socket angled M8
Number of positions	4

Cable/line

Cable length	0.5 m
--------------	-------

PVC yellow 105 °C [542]

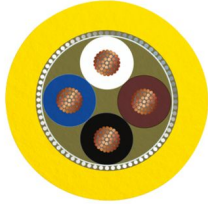
Dimensional drawing	
Cable weight	37 kg/km
UL AWM Style	2517 (105 °C / 300 V)
Number of positions	4
Shielded	yes
Cable type	PVC yellow 105 °C [542]
Conductor structure signal line	7x 0.20 mm
AWG signal line	24
Wire diameter incl. insulation	1.12 mm ±0.03 mm
External cable diameter	4.90 mm ±0.2 mm
Outer sheath, material	PVC
External sheath, color	yellow
Conductor material	Tin-plated Cu litz wires
Material wire insulation	PVC
Single wire, color	brown, blue, black, white
Overall twist	4 wires, twisted
Optical shield covering	85 %
Max. conductor resistance	max. 79.7 Ω/km (20 °C)
Insulation resistance	≥ (550 M Ohms/m @ 500V)
Nominal voltage, cable	300 V
Minimum bending radius, flexible installation	12 x D
Smallest bending radius, movable installation	59 mm

SAC-4P-M12MR/ 0,5-542/M8FRSHBK - Sensor/actuator cable



1406000

<https://www.phoenixcontact.com/us/products/1406000>

Flame resistance	FT4
Other resistance	UV resistant
Ambient temperature (operation)	-30 °C ... 105 °C (cable, fixed installation)

Environmental and real-life conditions

Ambient conditions

Degree of protection	IP65
	IP67
Ambient temperature (operation) (male connector/female connector)	-25 °C ... 90 °C (Plug / socket)

Standards and regulations

Standard designation	M12 connector
Standards/specifications	IEC 61076-2-101
Standard designation	M8 connector
Standards/specifications	IEC 61076-2-104

SAC-4P-M12MR/ 0,5-542/M8FRSHBK - Sensor/actuator cable

1406000

<https://www.phoenixcontact.com/us/products/1406000>

Drawings

Dimensional drawing



M12 x 1 male plug, angled, shielded

Dimensional drawing

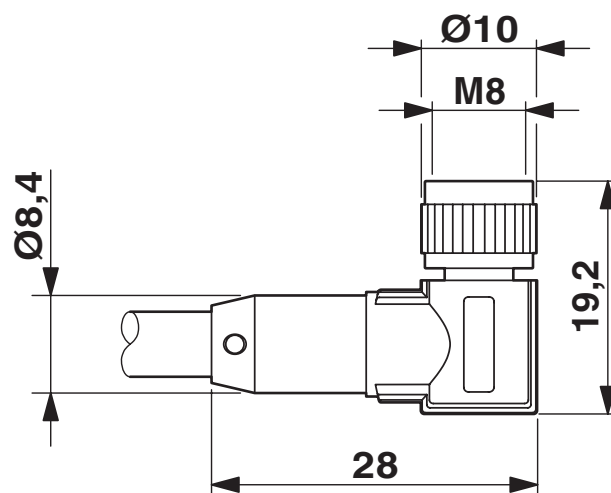

Socket M8 x 1, angled, shielded

SAC-4P-M12MR/ 0,5-542/M8FRSHBK - Sensor/actuator cable

1406000

<https://www.phoenixcontact.com/us/products/1406000>

Schematic diagram

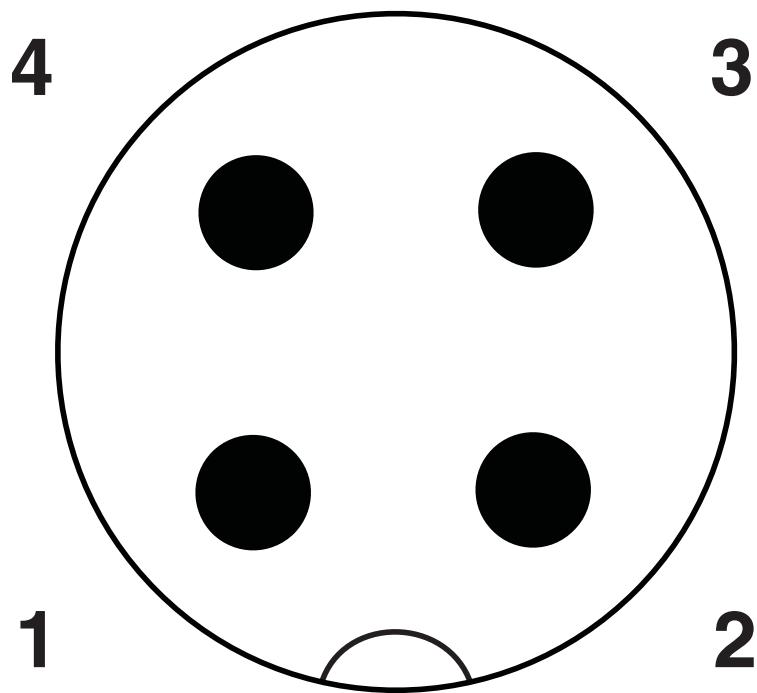

Pin assignment M12 plug, 4-pos., A-coded, view plug side

SAC-4P-M12MR/ 0,5-542/M8FRSHBK - Sensor/actuator cable

1406000

<https://www.phoenixcontact.com/us/products/1406000>

Schematic diagram



Pin assignment M8 socket, 4-pos., view female side

Schematic diagram

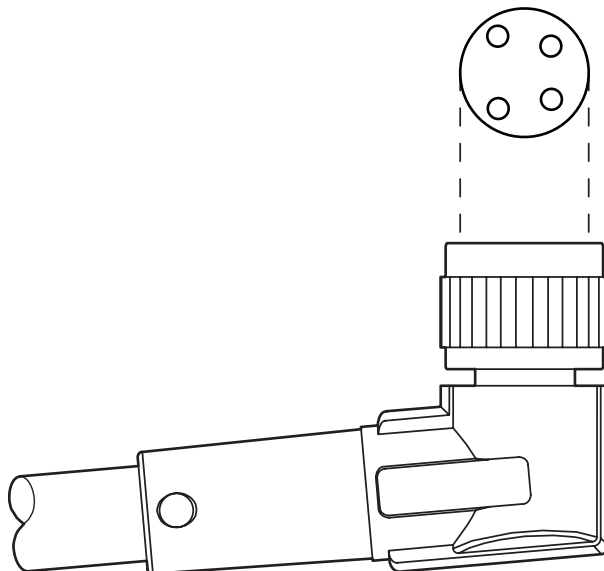

Layout of connector pin assignments

SAC-4P-M12MR/ 0,5-542/M8FRSHBK - Sensor/actuator cable

1406000

<https://www.phoenixcontact.com/us/products/1406000>

Circuit diagram

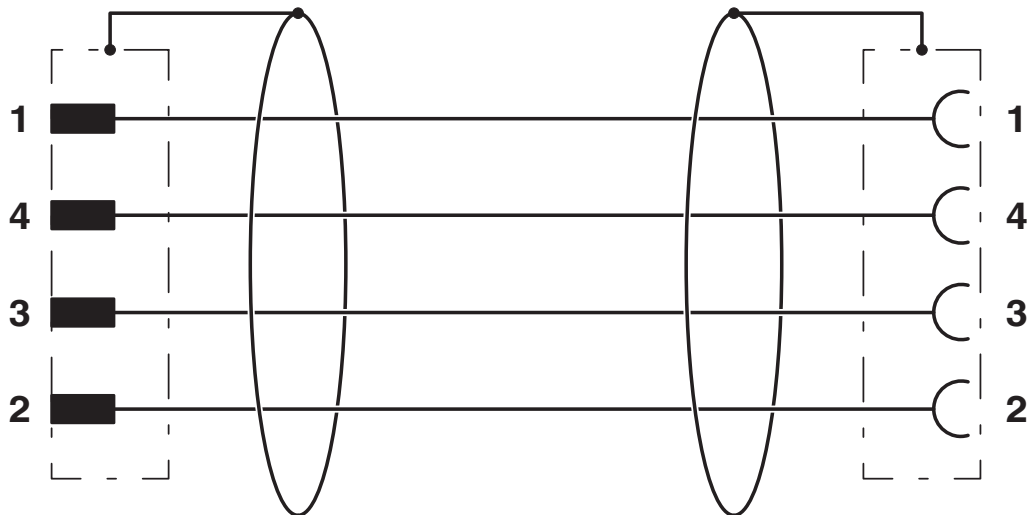

Contact assignment of M12 plugs / M8 sockets

SAC-4P-M12MR/ 0,5-542/M8FRSHBK - Sensor/actuator cable



1406000

<https://www.phoenixcontact.com/us/products/1406000>

Classifications

ECLASS

ECLASS-13.0	27060311
ECLASS-15.0	27060311

ETIM

ETIM 9.0	EC001855
----------	----------

UNSPSC

UNSPSC 21.0	26121600
-------------	----------

SAC-4P-M12MR/ 0,5-542/M8FRSHBK - Sensor/actuator cable



1406000

<https://www.phoenixcontact.com/us/products/1406000>

Environmental product compliance

EU RoHS

Fulfills EU RoHS substance requirements	Yes, No exemptions
---	--------------------

China RoHS

Environment friendly use period (EFUP)	EFUP-E
	No hazardous substances above the limits

EU REACH SVHC

REACH candidate substance (CAS No.)	No substance above 0.1 wt%
-------------------------------------	----------------------------

Phoenix Contact 2026 © - all rights reserved
<https://www.phoenixcontact.com>

Phoenix Contact USA
586 Fulling Mill Road
Middletown, PA 17057, United States
(+717) 944-1300
info@phoenixcon.com