

SAC-5P- 5,0-115/M 8FRB - Sensor/actuator cable



1404477

<https://www.phoenixcontact.com/us/products/1404477>

Please be informed that the data shown in this PDF document is generated from our online catalog. Please find the complete data in the user documentation. Our general terms of use for downloads are valid.



Sensor/actuator cable, 5-position, PUR halogen-free, black-gray RAL 7021, free cable end, on Socket angled M8, coding: B, cable length: 5 m

Your advantages

- Easy and safe: 100 % electrically tested plug-in components

Commercial data

Item number	1404477
Packing unit	1 pc
Minimum order quantity	1 pc
Sales key	BF01
Product key	AF1BDA
GTIN	4046356697149
Weight per piece (including packing)	157.9 g
Weight per piece (excluding packing)	144.5 g
Customs tariff number	85444290
Country of origin	PL

1404477

<https://www.phoenixcontact.com/us/products/1404477>

Technical data

Product properties

Product type	Sensor/actuator cable
Application	Standard
Number of positions	5
No. of cable outlets	1
Shielded	no
Coding	B

Insulation characteristics

Overvoltage category	II
Degree of pollution	3

Material specifications

Flammability rating according to UL 94	HB
Seal material	NBR
Material of grip body	TPU, hardly inflammable, self-extinguishing
Contact material	CuSn
Contact surface material	Ni/Au
Contact carrier material	TPU GF
Material for screw connection	Zinc die-cast, nickel-plated

Electrical properties

Insulation resistance	$\geq 100 \text{ M}\Omega$
Nominal voltage U_N	30 V AC
	30 V DC
Nominal current I_N	3 A

Mechanical properties

Mechanical data

Insertion/withdrawal cycles	≥ 100
-----------------------------	------------

Signaling

Status display	no
Status display present	no

Connection data

Conductor connection

Tightening torque	0.2 Nm (M8 connectors)
-------------------	------------------------

Connector

Connection 1

SAC-5P- 5,0-115/M 8FRB - Sensor/actuator cable



1404477

<https://www.phoenixcontact.com/us/products/1404477>

Type	free cable end
------	----------------

Connection 2

Type	Socket angled M8
Number of positions	5
Coding type	B

Cable/line

Cable length	5 m
--------------	-----

PUR, black, 5th conductor gray [115]

Cable weight	30 kg/km
UL AWM Style	20549
Number of positions	5
Shielded	no
Cable type	PUR, black, 5th conductor gray [115]
Conductor structure signal line	32x 0.10 mm
AWG signal line	24
Conductor cross-section	0.25 mm ²
Wire diameter incl. insulation	1.17 mm ±0.02 mm
External cable diameter	4.70 mm ±0.15 mm
Outer sheath, material	PUR
External sheath, color	black-gray RAL 7021
Conductor material	Bare Cu litz wires
Material, filler	PP
Material wire insulation	PP
Single wire, color	brown, white, blue, black, gray
Thickness, insulation	approx. 0.21 mm (Core insulation) approx. 0.70 mm (Outer cable sheath)
Overall twist	5 cores, twisted
Length of twist, overall twist	75 mm
Max. conductor resistance	≤ 75 Ω/km
Insulation resistance	≥ 1 GΩ*km
Nominal voltage, cable	≤ 300 V (AC)
Test voltage	≥ 3000 V (AC)
Smallest bending radius, fixed installation	23.5 mm
Smallest bending radius, movable installation	47 mm
Dynamic load capacity (bending)	Max. bending cycles: 10000000, Bending radius: 47 mm, Traversing path: 10 m, Traversing rate: 3 m/s, Acceleration: 10 m/s ²
Dynamic load capacity (torsion)	Torsion: ±180 °/m, Torsion cycles: ≥5000000, Torsional frequency: 35 cycles/min.
Halogen-free	in accordance with DIN VDE 0472 part 815 in accordance with DIN EN 50267-2-1
Flame resistance	according to UL 758/1581 (horizontal) in accordance with UL 758/1581 FT2

SAC-5P- 5,0-115/M 8FRB - Sensor/actuator cable



1404477

<https://www.phoenixcontact.com/us/products/1404477>

Resistance to oil	According to DIN EN 60811-2-1, 168 h at 100°C
Other resistance	hydrolysis and microbe resistant
	Resistant to salt water
	Low adhesion
	abrasion-resistant
Ambient temperature (operation)	-40 °C ... 80 °C (cable, fixed installation)
	-25 °C ... 80 °C (Cable, flexible installation)

Environmental and real-life conditions

Ambient conditions

Degree of protection	IP65
	IP67
	IP68
Ambient temperature (operation) (male connector/female connector)	-25 °C ... 90 °C (Plug / socket)

Standards and regulations

Standard designation	M8 connector
Standards/specifications	IEC 61076-2-104

SAC-5P- 5,0-115/M 8FRB - Sensor/actuator cable

1404477

<https://www.phoenixcontact.com/us/products/1404477>

Drawings

Dimensional drawing



Socket M8 x 1, angled

Schematic diagram

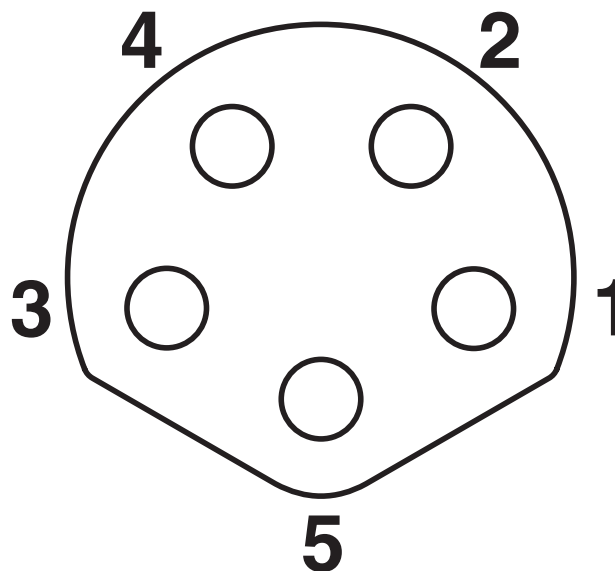

Pin assignment, socket side, M8, 5-pos., B-coded

SAC-5P- 5,0-115/M 8FRB - Sensor/actuator cable



1404477

<https://www.phoenixcontact.com/us/products/1404477>

Circuit diagram



Contact assignment of M8 socket

SAC-5P- 5,0-115/M 8FRB - Sensor/actuator cable



1404477

<https://www.phoenixcontact.com/us/products/1404477>

Approvals

To download certificates, visit the product detail page: <https://www.phoenixcontact.com/us/products/1404477>

 UL Listed Approval ID: FILE E 221474				
	Nominal voltage U_N	Nominal current I_N	Cross section AWG	Cross section mm^2
keine				
	30 V	3 A	-	-

 cUL Listed Approval ID: FILE E 221474				
	Nominal voltage U_N	Nominal current I_N	Cross section AWG	Cross section mm^2
keine				
	30 V	3 A	-	-

 EAC-RoHS Approval ID: RU D-DE.HB35.B.00387	
--	--

SAC-5P- 5,0-115/M 8FRB - Sensor/actuator cable



1404477

<https://www.phoenixcontact.com/us/products/1404477>

Classifications

ECLASS

ECLASS-13.0	27060311
ECLASS-15.0	27060311

ETIM

ETIM 10.0	EC001855
-----------	----------

UNSPSC

UNSPSC 21.0	26121600
-------------	----------

SAC-5P- 5,0-115/M 8FRB - Sensor/actuator cable



1404477

<https://www.phoenixcontact.com/us/products/1404477>

Environmental product compliance

EU RoHS

Fulfills EU RoHS substance requirements	Yes, No exemptions
---	--------------------

China RoHS

Environment friendly use period (EFUP)	EFUP-E
	No hazardous substances above the limits

EU REACH SVHC

REACH candidate substance (CAS No.)	No substance above 0.1 wt%
-------------------------------------	----------------------------

EF3.1 Climate Change

CO2e kg	2.093 kg CO2e
---------	---------------

Phoenix Contact 2026 © - all rights reserved
<https://www.phoenixcontact.com>

Phoenix Contact USA
586 Fulling Mill Road
Middletown, PA 17057, United States
(+717) 944-1300
info@phoenixcon.com