

VS-PPC-C2-MSTB-MNNA-P13-A5-SPOL - Connector component



1404249

<https://www.phoenixcontact.com/us/products/1404249>

Please be informed that the data shown in this PDF document is generated from our online catalog. Please find the complete data in the user documentation. Our general terms of use for downloads are valid.

Connector component, degree of protection: IP65, number of positions: 5



Commercial data

Item number	1404249
Packing unit	1 pc
Minimum order quantity	1 pc
Product key	ABNOHA
GTIN	4046356303798
Weight per piece (including packing)	88.95 g
Weight per piece (excluding packing)	88.95 g
Country of origin	DE

VS-PPC-C2-MSTB-MNNA-P13-A5-SPOL - Connector component



1404249

<https://www.phoenixcontact.com/us/products/1404249>

Technical data

Product properties

Number of positions

5

Environmental and real-life conditions

Ambient conditions

Degree of protection

IP65

VS-PPC-C2-MSTB-MNNA-P13-A5-SPOL - Connector component



1404249

<https://www.phoenixcontact.com/us/products/1404249>

Drawings

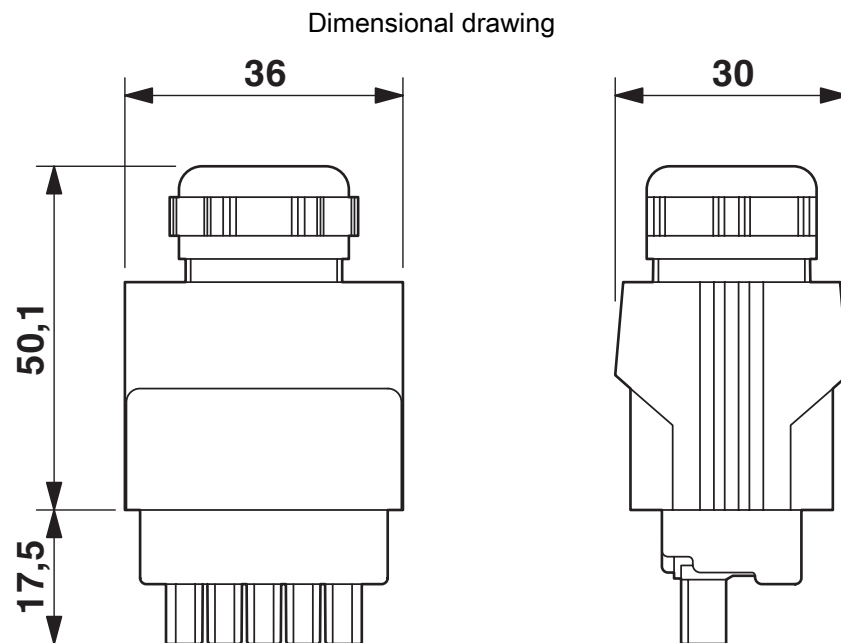

Push-pull MSTB connector

Phoenix Contact 2026 © - all rights reserved
<https://www.phoenixcontact.com>

Phoenix Contact USA
586 Fulling Mill Road
Middletown, PA 17057, United States
(+717) 944-1300
info@phoenixcon.com