

SAC-3P- 5,0-PUR/B-1L-R-ES - Sensor/actuator cable



1401338

<https://www.phoenixcontact.com/us/products/1401338>

Please be informed that the data shown in this PDF document is generated from our online catalog. Please find the complete data in the user documentation. Our general terms of use for downloads are valid.



Sensor/actuator cable, 3-position, PUR halogen-free, black-gray RAL 7021, free cable end, on Valve connector B (10 mm), with 1 LED, Wiring: Freewheeling diode with holding current limiting device, cable length: 5 m, with holding current limiting device for energy reduction

Commercial data

Item number	1401338
Packing unit	1 pc
Minimum order quantity	1 pc
Product key	AF1DCA
GTIN	4046356924573
Weight per piece (including packing)	168 g
Weight per piece (excluding packing)	168 g
Country of origin	DE

Technical data

Product properties

Product type	Sensor/actuator cable with valve connector
Application	Standard
Number of positions	3
No. of cable outlets	1
Shielded	no

Material specifications

Seal material	TPU
Material housing valve plug	TPU
Contact material	CuSn
Valve plug contact insert material	PA 6.6
Contact surface material	Ag

Electrical properties

Insulation resistance	$\geq 100 \text{ M}\Omega$
Nominal voltage U_N	24 V DC $\pm 20 \%$
Nominal current I_N	1 A

Valve connector characteristics

Switch-over time	approx. 200 ms (Initial operating time)
Clock frequency	approx. 2500 Hz (Holding current limiting device)
Switching frequency	max. 5 Hz (Connected valve)
Fixing screws	M3 x 28

Signaling

Status display	1 LED
Status display present	yes

Connector

Connection 1

Type	free cable end
------	----------------

Connection 2

Type	Valve connector B (10 mm)
Number of positions	3
Material	CuSn (Contact)
	Ag (Contact surface)
	PBT (Contact carrier)
	TPU (Housing)
Protective circuit	Freewheeling diode with holding current limiting device

SAC-3P- 5,0-PUR/B-1L-R-ES - Sensor/actuator cable



1401338

<https://www.phoenixcontact.com/us/products/1401338>

Cable/line

Cable length	5 m
--------------	-----

PUR halogen-free black [PUR]

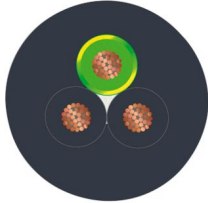
Dimensional drawing	
Cable weight	30 kg/km
UL AWM Style	20549
Number of positions	3
Shielded	no
Cable type	PUR halogen-free black [PUR]
Conductor structure signal line	28x 0.15 mm
AWG signal line	20
Conductor cross-section	3x 0.5 mm ²
Wire diameter incl. insulation	1.5 mm ±0.05 mm (Signal line)
External cable diameter	4.50 mm ±0.2 mm
Outer sheath, material	PUR
External sheath, color	black-gray RAL 7021
Conductor material	Bare Cu litz wires
Material wire insulation	PP
Single wire, color	black 1, black 2, green/yellow
Overall twist	3 wires, twisted
Max. conductor resistance	39 Ω/km (at 20 °C)
Insulation resistance	min. 20 MΩ*km
Nominal voltage, cable	≤ 300 V
Test voltage	≥ 1200 V
Minimum bending radius, fixed installation	5 x D
Minimum bending radius, flexible installation	10 x D
Smallest bending radius, fixed installation	22.5 mm
Smallest bending radius, movable installation	45 mm
Dynamic load capacity (bending)	Max. bending cycles: 15000000, Bending radius: 50 mm, Traversing path: 0.9 m, Traversing rate: 5 m/s, Acceleration: 30 m/s ²
Halogen-free	in accordance with DIN VDE 0472 part 815
Flame resistance	according to DIN VDE 0482 According to DIN EN 50265-2-1
Resistance to oil	in accordance with DIN EN 60811-2-1
Other resistance	largely oil-resistant

SAC-3P- 5,0-PUR/B-1L-R-ES - Sensor/actuator cable



1401338

<https://www.phoenixcontact.com/us/products/1401338>

	partly UV-resistant (in accordance with DIN EN ISO 4892-2-A)
Ambient temperature (operation)	-40 °C ... 80 °C (cable, fixed installation)
	-20 °C ... 80 °C (Cable, flexible installation)

Environmental and real-life conditions

Ambient conditions

Degree of protection	IP67
Ambient temperature (operation) (Valve connector)	-25 °C ... 80 °C (Valve connector)

Standards and regulations

Valve connector

Standard designation	Valve connector
Standards/specifications	EN 175301-803

Drawings

Dimensional drawing

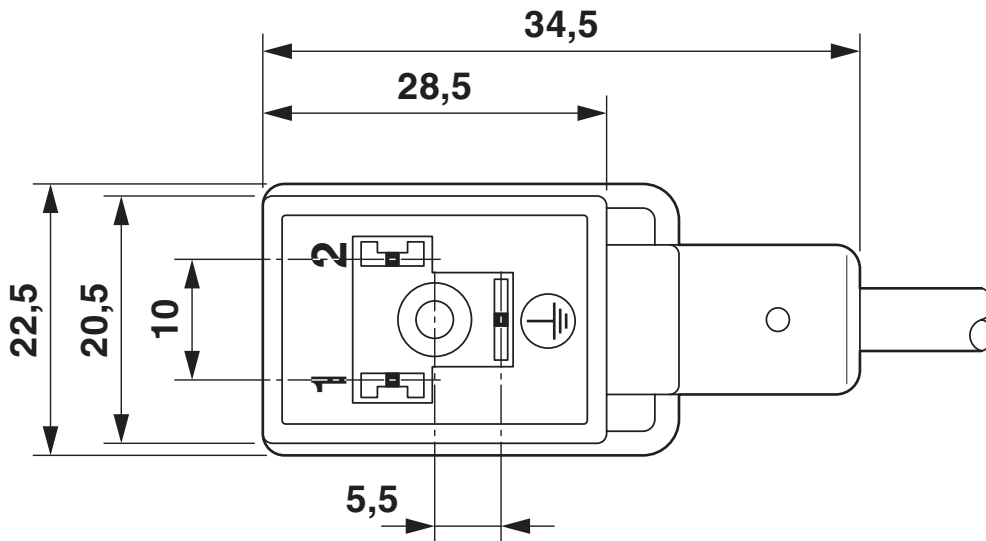

Valve connector, type B

Dimensional drawing



Valve connector, type B, side view

Schematic diagram

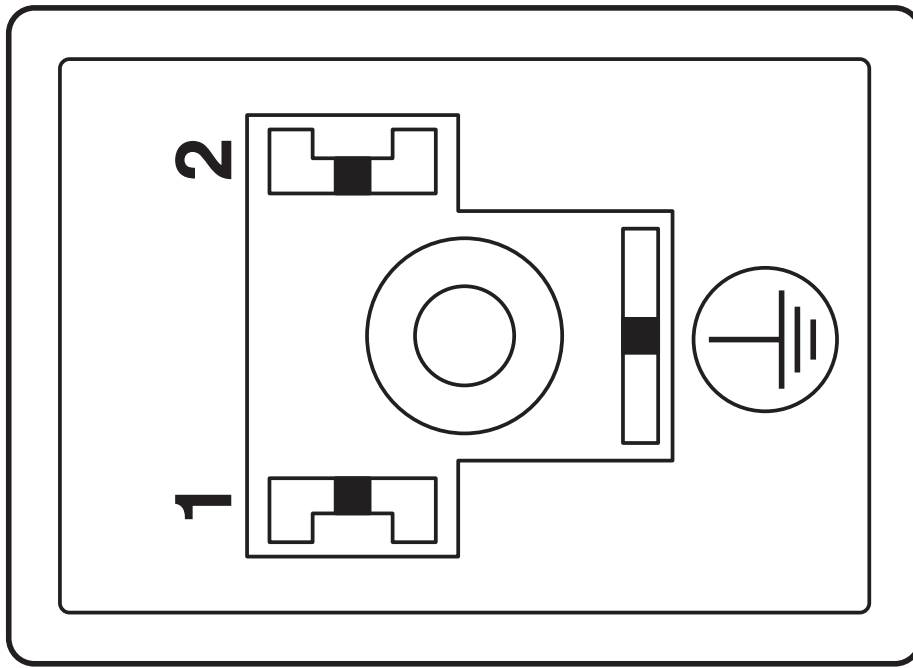

Valve connector pin assignment, type B

Circuit diagram

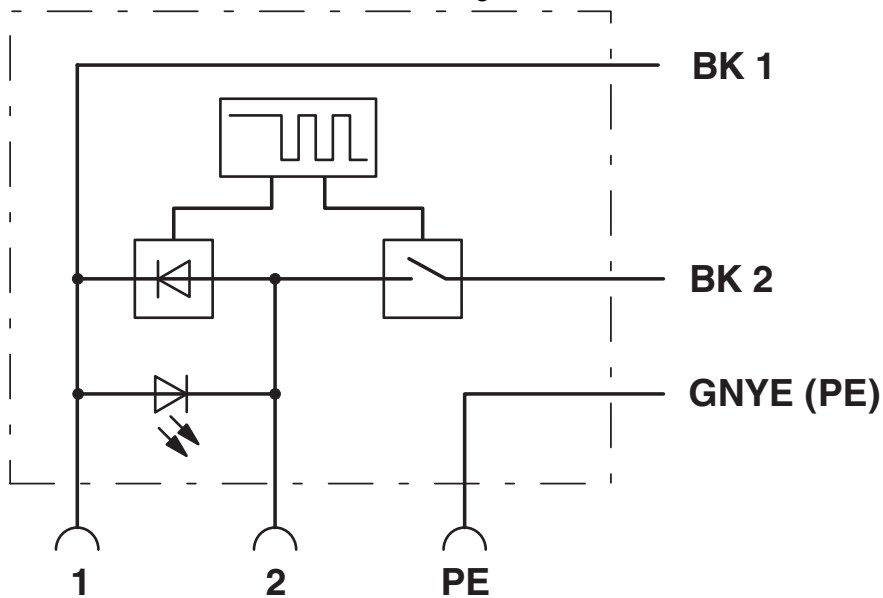

Contact assignment of the valve plug

SAC-3P- 5,0-PUR/B-1L-R-ES - Sensor/actuator cable



1401338

<https://www.phoenixcontact.com/us/products/1401338>

Classifications

ECLASS

ECLASS-13.0	27060312
ECLASS-15.0	27060312

ETIM

ETIM 9.0	EC001855
----------	----------

UNSPSC

UNSPSC 21.0	31251500
-------------	----------

SAC-3P- 5,0-PUR/B-1L-R-ES - Sensor/actuator cable



1401338

<https://www.phoenixcontact.com/us/products/1401338>

Environmental product compliance

EU RoHS

Fulfills EU RoHS substance requirements	Yes, No exemptions
---	--------------------

China RoHS

Environment friendly use period (EFUP)	EFUP-E
	No hazardous substances above the limits

EU REACH SVHC

REACH candidate substance (CAS No.)	No substance above 0.1 wt%
-------------------------------------	----------------------------

Phoenix Contact 2026 © - all rights reserved
<https://www.phoenixcontact.com>

Phoenix Contact USA
586 Fulling Mill Road
Middletown, PA 17057, United States
(+717) 944-1300
info@phoenixcon.com