

# SAC-3P-5,0-PUR/C - Sensor/actuator cable



1400814

<https://www.phoenixcontact.com/us/products/1400814>

Please be informed that the data shown in this PDF document is generated from our online catalog. Please find the complete data in the user documentation. Our general terms of use for downloads are valid.



Sensor/actuator cable, 3-position, PUR halogen-free, black-gray RAL 7021, free cable end, on Valve connector C (8 mm), Wiring: unwired, cable length: 5 m

## Your advantages

- Easy and safe: 100 % electrically tested plug-in components
- Our standard: robust halogen-free PUR cable

## Commercial data

Item number	1400814
Packing unit	1 pc
Minimum order quantity	1 pc
Sales key	BF07
Product key	AF1DEA
GTIN	4046356513135
Weight per piece (including packing)	166.8 g
Weight per piece (excluding packing)	155.4 g
Customs tariff number	85444290
Country of origin	PL

1400814

<https://www.phoenixcontact.com/us/products/1400814>

## Technical data

### Product properties

Product type	Sensor/actuator cable with valve connector
Application	Standard
Number of positions	3
No. of cable outlets	1
Shielded	no

### Insulation characteristics

Overvoltage category	III
Degree of pollution	2

### Connection data

#### Conductor connection

Tightening torque	0.6 Nm (Valve connector)
-------------------	--------------------------

### Material specifications

Flammability rating according to UL 94	V0
Seal material	TPU
Material housing valve plug	TPU
Contact material	CuSn
Valve plug contact insert material	PA 6.6
Contact surface material	Sn

### Electrical properties

Insulation resistance	≥ 100 MΩ
Nominal voltage $U_N$	230 V AC
	230 V DC
Nominal current $I_N$	6 A

#### Valve connector characteristics

Fixing screws	M2,5 x 27,5
---------------	-------------

### Signaling

Status display	no
Status display present	no

### Connector

#### Connection 1

Type	free cable end
------	----------------

#### Connection 2

Type	Valve connector C (8 mm)
------	--------------------------

# SAC-3P-5,0-PUR/C - Sensor/actuator cable



1400814

<https://www.phoenixcontact.com/us/products/1400814>

Material	CuSn (Contact)
	Sn (Contact surface)
	PA 6.6 (Contact carrier)
	TPU (Housing)
Protective circuit	unwired

## Cable/line

Cable length	5 m
--------------	-----

### PUR halogen-free black [PUR]

Dimensional drawing	
Cable weight	30 kg/km
UL AWM Style	20549
Number of positions	3
Shielded	no
Cable type	PUR halogen-free black [PUR]
Conductor structure signal line	28x 0.15 mm
AWG signal line	20
Conductor cross-section	3x 0.5 mm <sup>2</sup>
Wire diameter incl. insulation	1.5 mm ±0.05 mm (Signal line)
External cable diameter	4.50 mm ±0.2 mm
Outer sheath, material	PUR
External sheath, color	black-gray RAL 7021
Conductor material	Bare Cu litz wires
Material wire insulation	PP
Single wire, color	black 1, black 2, green/yellow
Overall twist	3 wires, twisted
Max. conductor resistance	39 Ω/km (at 20 °C)
Insulation resistance	min. 20 MΩ*km
Nominal voltage, cable	≤ 300 V
Test voltage	≥ 1200 V
Minimum bending radius, fixed installation	5 x D
Minimum bending radius, flexible installation	10 x D
Smallest bending radius, fixed installation	22.5 mm
Smallest bending radius, movable installation	45 mm
Dynamic load capacity (bending)	Max. bending cycles: 15000000, Bending radius: 50 mm, Traversing path: 0.9 m, Traversing rate: 5 m/s, Acceleration: 30 m/s <sup>2</sup>

# SAC-3P-5,0-PUR/C - Sensor/actuator cable



1400814

<https://www.phoenixcontact.com/us/products/1400814>

Halogen-free	in accordance with DIN VDE 0472 part 815
Flame resistance	according to DIN VDE 0482
	According to DIN EN 50265-2-1
Resistance to oil	in accordance with DIN EN 60811-2-1
Other resistance	largely oil-resistant
	partly UV-resistant (in accordance with DIN EN ISO 4892-2-A)
Ambient temperature (operation)	-40 °C ... 80 °C (cable, fixed installation)
	-20 °C ... 80 °C (Cable, flexible installation)

## Environmental and real-life conditions

### Ambient conditions

Degree of protection	IP65
	IP67
Ambient temperature (operation) (Valve connector)	-20 °C ... 85 °C (Valve connector)
Ambient temperature (operation) (Cable, fixed installation)	-40 °C ... 80 °C (cable, fixed installation)
Ambient temperature (operation) (Cable, flexible installation)	-15 °C ... 80 °C (Cable, flexible installation)

## Standards and regulations

### Valve connector

Standard designation	Valve connector
Standards/specifications	EN 175301-803

# SAC-3P-5,0-PUR/C - Sensor/actuator cable

1400814

<https://www.phoenixcontact.com/us/products/1400814>

## Drawings

Dimensional drawing

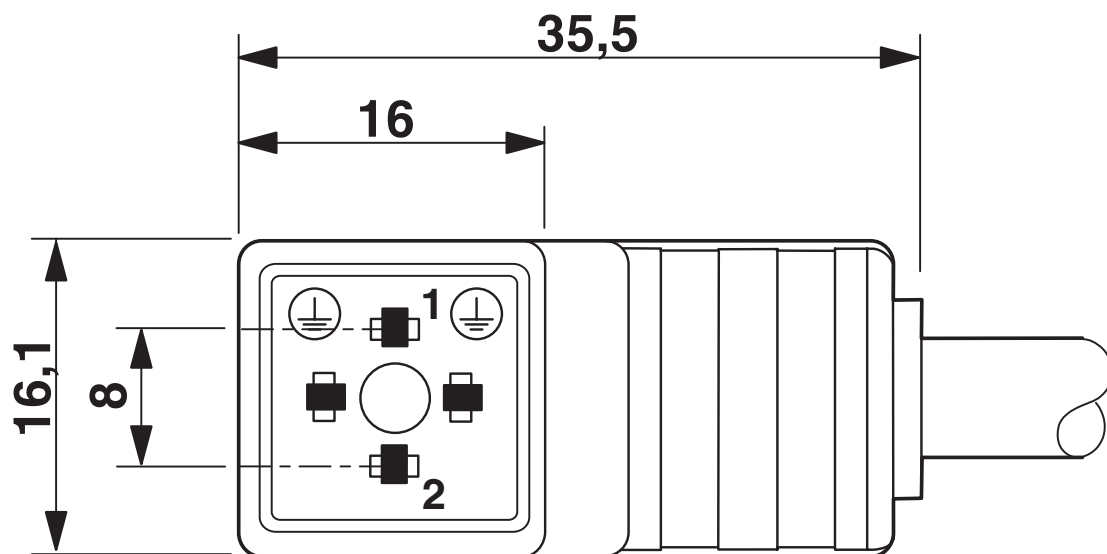

Valve connector, type C

Dimensional drawing

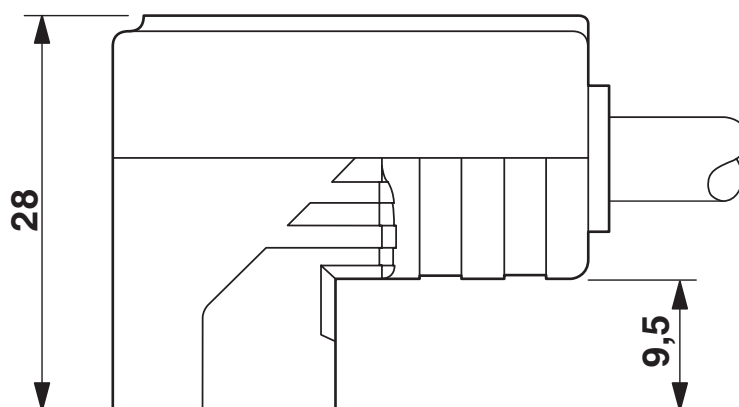

Valve connector, type C, side view

Schematic diagram

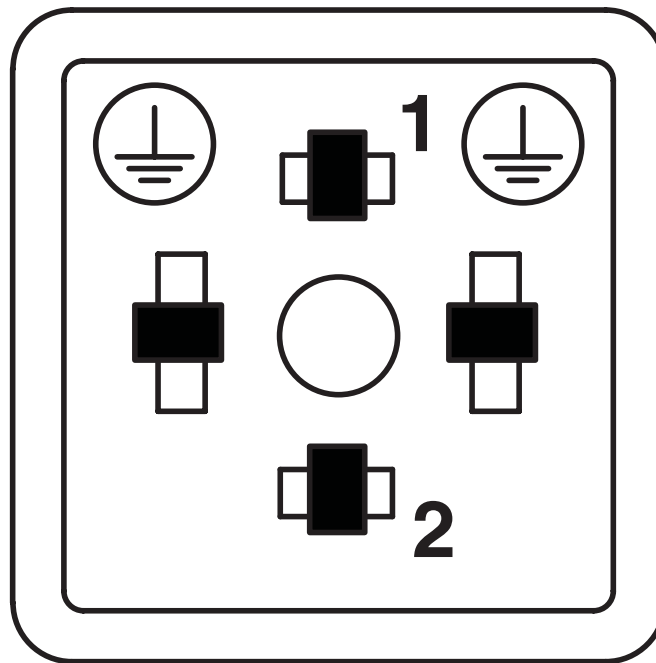

Valve connector connector pin assignment, type C

Diagram

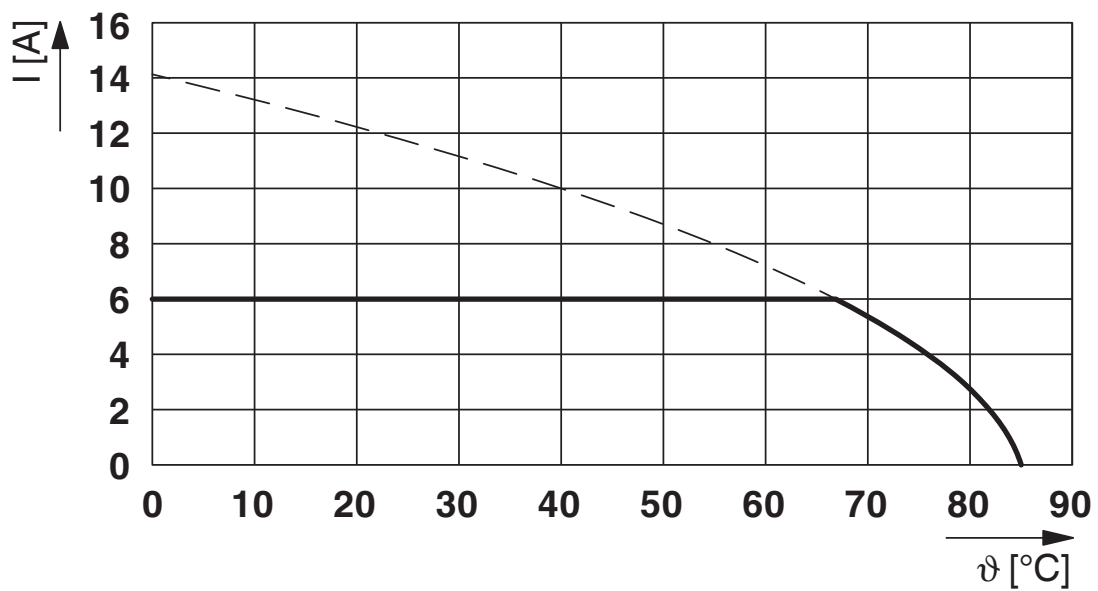

Derating diagram

# SAC-3P-5,0-PUR/C - Sensor/actuator cable



1400814

<https://www.phoenixcontact.com/us/products/1400814>

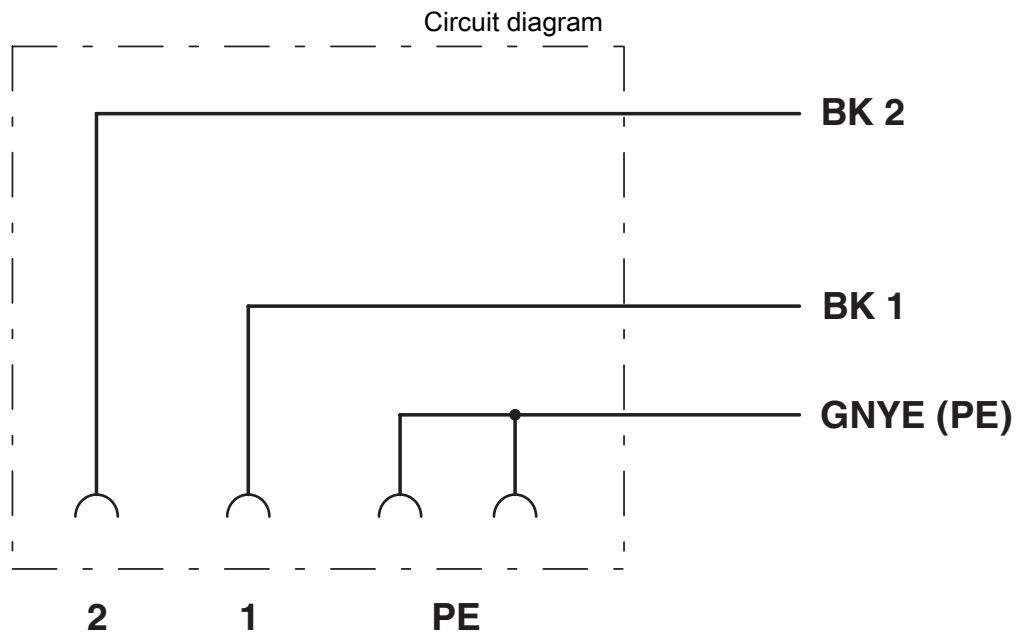

Contact assignment of the valve plug

# SAC-3P-5,0-PUR/C - Sensor/actuator cable



1400814

<https://www.phoenixcontact.com/us/products/1400814>

## Approvals

To download certificates, visit the product detail page: <https://www.phoenixcontact.com/us/products/1400814>

 <b>CSAus</b> Approval ID: 13631				
	Nominal voltage $U_N$	Nominal current $I_N$	Cross section AWG	Cross section $\text{mm}^2$
keine				
	230 V	6 A	-	-

# SAC-3P-5,0-PUR/C - Sensor/actuator cable



1400814

<https://www.phoenixcontact.com/us/products/1400814>

## Classifications

### ECLASS

ECLASS-13.0	27060312
ECLASS-15.0	27060312

### ETIM

ETIM 10.0	EC001855
-----------	----------

### UNSPSC

UNSPSC 21.0	31251500
-------------	----------

# SAC-3P-5,0-PUR/C - Sensor/actuator cable



1400814

<https://www.phoenixcontact.com/us/products/1400814>

## Environmental product compliance

### EU RoHS

Fulfills EU RoHS substance requirements	Yes, No exemptions
---	--------------------

### China RoHS

Environment friendly use period (EFUP)	EFUP-E
	No hazardous substances above the limits

### EU REACH SVHC

REACH candidate substance (CAS No.)	No substance above 0.1 wt%
-------------------------------------	----------------------------

### EF3.1 Climate Change

CO2e kg	5.464 kg CO2e
---------	---------------

Phoenix Contact 2026 © - all rights reserved  
<https://www.phoenixcontact.com>

Phoenix Contact USA  
586 Fulling Mill Road  
Middletown, PA 17057, United States  
(+717) 944-1300  
[info@phoenixcon.com](mailto:info@phoenixcon.com)