

SEALING PLUG 13X22 RD - Sealing plug



1400265

<https://www.phoenixcontact.com/us/products/1400265>

Please be informed that the data shown in this PDF document is generated from our online catalog. Please find the complete data in the user documentation. Our general terms of use for downloads are valid.

Sealing plug, color: red



Commercial data

Item number	1400265
Packing unit	10 pc
Minimum order quantity	10 pc
Sales key	BF68
Product key	AF7DZX
GTIN	4046356478748
Weight per piece (including packing)	2.32 g
Weight per piece (excluding packing)	2.32 g
Customs tariff number	39235090
Country of origin	DE

SEALING PLUG 13X22 RD - Sealing plug



1400265

<https://www.phoenixcontact.com/us/products/1400265>

Technical data

Product properties

Product type	Sealing plugs
--------------	---------------

Dimensions

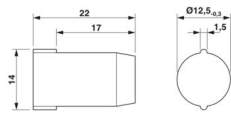
Dimensional drawing	
Width	12.50 mm
Length	22 mm
Diameter	12.5 mm
Diameter	12.5 mm

Material specifications

Material	PA
----------	----

Environmental and real-life conditions

Ambient conditions

Ambient temperature (operation)	-60 °C ... 100 °C
---------------------------------	-------------------

Mounting

Assembly note	The head of the sealing plug must still be visible after mounting in the screw connection (see "after mounting" photo).
---------------	---

SEALING PLUG 13X22 RD - Sealing plug



1400265

<https://www.phoenixcontact.com/us/products/1400265>

Drawings

Dimensional drawing

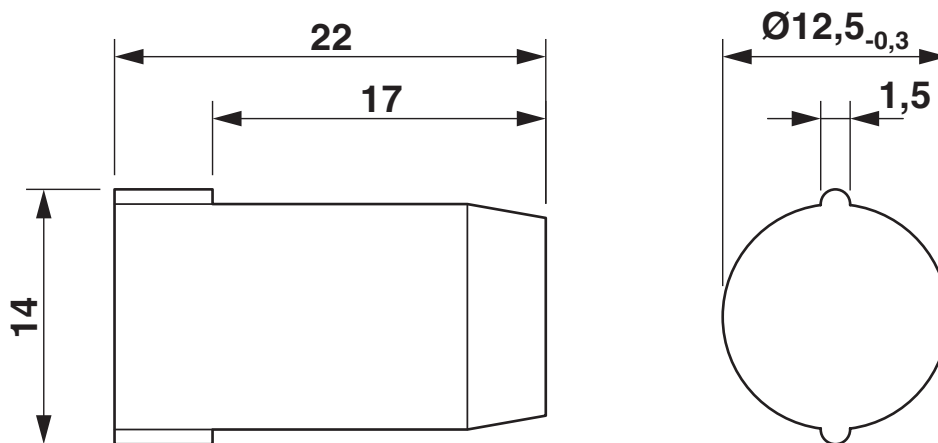

Dimensional drawing

SEALING PLUG 13X22 RD - Sealing plug



1400265

<https://www.phoenixcontact.com/us/products/1400265>

Classifications

ECLASS

ECLASS-13.0	23111190
ECLASS-15.0	27140805

ETIM

ETIM 10.0	EC002610
-----------	----------

UNSPSC

UNSPSC 21.0	39121300
-------------	----------

SEALING PLUG 13X22 RD - Sealing plug



1400265

<https://www.phoenixcontact.com/us/products/1400265>

Environmental product compliance

EU RoHS

Fulfills EU RoHS substance requirements	Yes, No exemptions
---	--------------------

China RoHS

Environment friendly use period (EFUP)	EFUP-E
	No hazardous substances above the limits

EU REACH SVHC

REACH candidate substance (CAS No.)	No substance above 0.1 wt%
-------------------------------------	----------------------------

Phoenix Contact 2026 © - all rights reserved
<https://www.phoenixcontact.com>

Phoenix Contact USA
586 Fulling Mill Road
Middletown, PA 17057, United States
(+717) 944-1300
info@phoenixcon.com