

SEALING PLUG 5X12 RD - Sealing plug



1400253

<https://www.phoenixcontact.com/us/products/1400253>

Please be informed that the data shown in this PDF document is generated from our online catalog. Please find the complete data in the user documentation. Our general terms of use for downloads are valid.

Sealing plug, color: red



Commercial data

| | |
|--------------------------------------|---------------|
| Item number | 1400253 |
| Packing unit | 10 pc |
| Minimum order quantity | 10 pc |
| Sales key | BF68 |
| Product key | AF7DZX |
| GTIN | 4046356478687 |
| Weight per piece (including packing) | 0.49 g |
| Weight per piece (excluding packing) | 0.45 g |
| Customs tariff number | 39235090 |
| Country of origin | DE |

SEALING PLUG 5X12 RD - Sealing plug

1400253

<https://www.phoenixcontact.com/us/products/1400253>

Technical data

Product properties

| | |
|--------------|---------------|
| Product type | Sealing plugs |
|--------------|---------------|

Dimensions

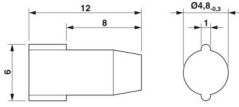
| | |
|---------------------|--|
| Dimensional drawing |  |
| Width | 4.80 mm |
| Length | 12 mm |
| Diameter | 4.8 mm |
| Diameter | 4.8 mm |

Material specifications

| | |
|----------|----|
| Material | PA |
|----------|----|

Environmental and real-life conditions

Ambient conditions

| | |
|---------------------------------|-------------------|
| Ambient temperature (operation) | -60 °C ... 100 °C |
|---------------------------------|-------------------|

Mounting

| | |
|---------------|---|
| Assembly note | The head of the sealing plug must still be visible after mounting in the screw connection (see "after mounting" photo). |
|---------------|---|

SEALING PLUG 5X12 RD - Sealing plug



1400253

<https://www.phoenixcontact.com/us/products/1400253>

Drawings

Dimensional drawing

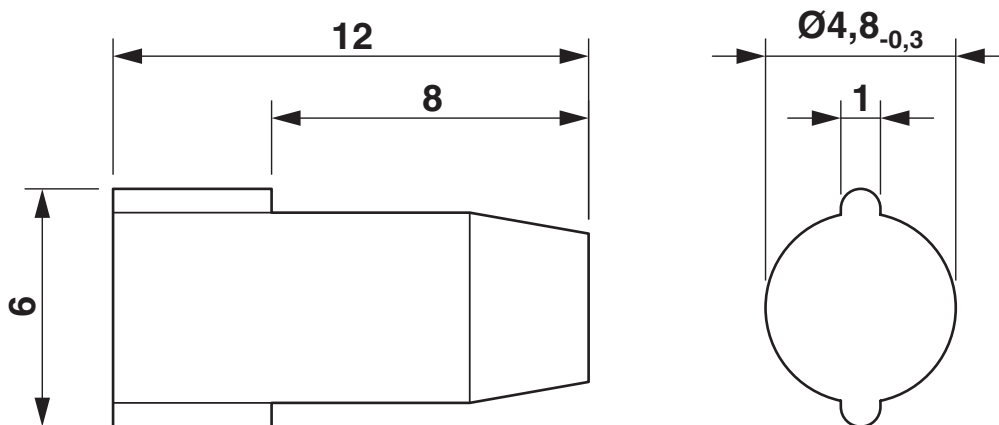

Dimensional drawing

SEALING PLUG 5X12 RD - Sealing plug



1400253

<https://www.phoenixcontact.com/us/products/1400253>

Classifications

ECLASS

| | |
|-------------|----------|
| ECLASS-13.0 | 23111190 |
| ECLASS-15.0 | 27140805 |

ETIM

| | |
|-----------|----------|
| ETIM 10.0 | EC002610 |
|-----------|----------|

UNSPSC

| | |
|-------------|----------|
| UNSPSC 21.0 | 39121300 |
|-------------|----------|

SEALING PLUG 5X12 RD - Sealing plug



1400253

<https://www.phoenixcontact.com/us/products/1400253>

Environmental product compliance

EU RoHS

| | |
|---|--------------------|
| Fulfills EU RoHS substance requirements | Yes, No exemptions |
|---|--------------------|

China RoHS

| | |
|--|--|
| Environment friendly use period (EFUP) | EFUP-E |
| | No hazardous substances above the limits |

EU REACH SVHC

| | |
|-------------------------------------|----------------------------|
| REACH candidate substance (CAS No.) | No substance above 0.1 wt% |
|-------------------------------------|----------------------------|

Phoenix Contact 2026 © - all rights reserved
<https://www.phoenixcontact.com>

Phoenix Contact USA
586 Fulling Mill Road
Middletown, PA 17057, United States
(+717) 944-1300
info@phoenixcon.com