

SEALING PLUG 3X12 RD - Sealing plug



1400238

<https://www.phoenixcontact.com/us/products/1400238>

Please be informed that the data shown in this PDF document is generated from our online catalog. Please find the complete data in the user documentation. Our general terms of use for downloads are valid.



Sealing plug, color: red

Commercial data

Item number	1400238
Packing unit	10 pc
Minimum order quantity	10 pc
Sales key	BF68
Product key	AF7DZX
GTIN	4046356478670
Weight per piece (including packing)	0.492 g
Weight per piece (excluding packing)	0.492 g
Customs tariff number	39235090
Country of origin	DE

SEALING PLUG 3X12 RD - Sealing plug



1400238

<https://www.phoenixcontact.com/us/products/1400238>

Technical data

Product properties

Product type	Sealing plugs
--------------	---------------

Dimensions

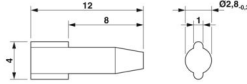
Dimensional drawing	
Width	2.80 mm
Length	12 mm
Diameter	2.8 mm
	2.8 mm

Material specifications

Material	PA
----------	----

Environmental and real-life conditions

Ambient conditions

Ambient temperature (operation)	-60 °C ... 100 °C
---------------------------------	-------------------

Mounting

Assembly note	The head of the sealing plug must still be visible after mounting in the screw connection (see "after mounting" photo).
---------------	---

SEALING PLUG 3X12 RD - Sealing plug

1400238

<https://www.phoenixcontact.com/us/products/1400238>



Drawings

Dimensional drawing

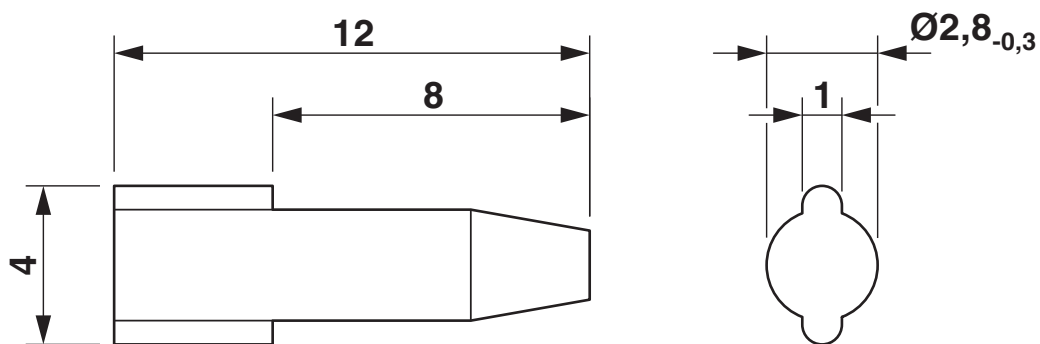

Dimensional drawing

SEALING PLUG 3X12 RD - Sealing plug



1400238

<https://www.phoenixcontact.com/us/products/1400238>

Classifications

ECLASS

ECLASS-13.0	23111190
ECLASS-15.0	27144492

ETIM

ETIM 10.0	EC002610
-----------	----------

UNSPSC

UNSPSC 21.0	39121300
-------------	----------

SEALING PLUG 3X12 RD - Sealing plug



1400238

<https://www.phoenixcontact.com/us/products/1400238>

Environmental product compliance

EU RoHS

Fulfills EU RoHS substance requirements	Yes, No exemptions
---	--------------------

China RoHS

Environment friendly use period (EFUP)	EFUP-E
	No hazardous substances above the limits

EU REACH SVHC

REACH candidate substance (CAS No.)	No substance above 0.1 wt%
-------------------------------------	----------------------------

Phoenix Contact 2026 © - all rights reserved
<https://www.phoenixcontact.com>

Phoenix Contact USA
586 Fulling Mill Road
Middletown, PA 17057, United States
(+717) 944-1300
info@phoenixcon.com