

# DD21H 0,85/ 8-PT-2,5-Y - Feed-through plug



1378115

<https://www.phoenixcontact.com/us/products/1378115>

Please be informed that the data shown in this PDF document is generated from our online catalog. Please find the complete data in the user documentation. Our general terms of use for downloads are valid.



CRIMP



BOX



Feed-through connector, color: black, nominal current: 5 A, rated voltage (III/2): 160 V, contact surface: Sn, contact connection type: Pin, number of rows: 2, number of positions: 8, product range: DD21H 0,85/..-PT, pitch: 2.5 mm, connection method: Crimp connection, conductor/PCB connection direction: 0 °, locking clip: - without locking clip, plug-in system: CONNEXIS DD, Pin connector pattern alignment: Standard, locking: Snap-in locking, mounting method: Engagement nose, type of packaging: packed in cardboard

## Your advantages

- Cost-effective connection of crimped conductors in large quantities
- Small component size for applications where space is at a premium
- Intuitive locking mechanism prevents accidental disconnection
- Tools for automatic crimping available as an option

## Commercial data

Item number	1378115
Packing unit	50 pc
Minimum order quantity	50 pc
Note	Made to order (non-returnable)
Sales key	AA01
Product key	AAACXG
GTIN	4063151745905
Weight per piece (including packing)	4.7 g
Weight per piece (excluding packing)	4.7 g
Customs tariff number	85366990
Country of origin	CN

# DD21H 0,85/ 8-PT-2,5-Y - Feed-through plug



1378115

<https://www.phoenixcontact.com/us/products/1378115>

## Technical data

### Product properties

Product type	Feed-through connector
Product family	DD21H 0,85/..-PT
Product line	CONNEXIS Connectors XS
Number of positions	8
Pitch	2.5 mm
Number of rows	2

### Electrical properties

#### Properties

Nominal current $I_N$	5 A
Nominal voltage $U_N$	160 V
Contact resistance	2.6 m $\Omega$
Rated voltage (III/3)	40 V
Rated surge voltage (III/3)	2.5 kV
Rated voltage (III/2)	160 V
Rated surge voltage (III/2)	2.5 kV
Rated voltage (II/2)	200 V
Rated surge voltage (II/2)	2.5 kV

### Connection data

#### Interlock

Locking type	Snap-in locking
Mounting type	Engagement nose

#### Conductor connection

Connection method	Crimp connection
Conductor cross-section AWG	28 ... 18
Stripping length	3 mm

### Material specifications

#### Material data - contact

Metal surface contact area (top layer)	Tin (Sn)
--	----------

#### Material data - housing

Color (Housing)	black (9005)
Insulating material	PBT
Insulating material group	II
CTI according to IEC 60112	$400 \leq CTI < 600$
Flammability rating according to UL 94	V0

# DD21H 0,85/ 8-PT-2,5-Y - Feed-through plug



1378115

<https://www.phoenixcontact.com/us/products/1378115>

## Notes

Note on the contact	These connectors conform to DIN EN 61984, connectors without switching power (COC). When used for their intended purpose, they must not be plugged in or disconnected live or under load.
---------------------	---

## Dimensions

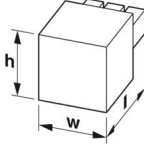
Dimensional drawing	
Pitch	2.5 mm
Width [w]	22.2 mm
Height [h]	16.2 mm
Length [l]	30.69 mm

## Mechanical tests

### Tensile strength of crimp connections

Result	Test passed
Conductor cross-section/conductor type/tractive force setpoint/actual value	AWG 28 / flexible / > 11 N

### Insertion and withdrawal forces

Result	Test passed
No. of cycles	25
Insertion strength per pos. approx.	2 N
Withdraw strength per pos. approx.	2 N

### Contact holder in insert

Specification	IEC 60512-15-1:2008-05
Contact holder in insert Requirements >20 N	Test passed

### Resistance of inscriptions

Specification	IEC 60068-2-70:1995-12
Result	Test passed

### Polarization and coding

Specification	IEC 60512-13-5:2006-02
Result	Test passed

### Visual inspection

Specification	IEC 60512-1-1:2002-02
Result	Test passed

### Dimension check

# DD21H 0,85/ 8-PT-2,5-Y - Feed-through plug



1378115

<https://www.phoenixcontact.com/us/products/1378115>

Specification	IEC 60512-1-2:2002-02
Result	Test passed

## Electrical tests

### Thermal test | Test group C

Specification	IEC 60512-5-1:2002-02
Tested number of positions	20

### Insulation resistance

Specification	IEC 60512-3-1:2002-02
Insulation resistance, neighboring positions	> 5 MΩ

### Air clearances and creepage distances |

Specification	IEC 60664-1:2020-05
Insulating material group	II
Comparative tracking index (IEC 60112)	CTI ≥400 to <600
Rated insulation voltage (III/3)	40 V
Rated surge voltage (III/3)	2.5 kV
minimum clearance value - non-homogenous field (III/3)	1.5 mm
minimum creepage distance (III/3)	1.6 mm
Rated insulation voltage (III/2)	160 V
Rated surge voltage (III/2)	2.5 kV
minimum clearance value - non-homogenous field (III/2)	1.5 mm
minimum creepage distance (III/2)	1.5 mm
Rated insulation voltage (II/2)	200 V
Rated surge voltage (II/2)	2.5 kV
minimum clearance value - non-homogenous field (II/2)	1.5 mm
minimum creepage distance (II/2)	1.5 mm

## Environmental and real-life conditions

### Durability test

Specification	IEC 60512-9-1:2010-03
Impulse withstand voltage at sea level	2.95 kV
Contact resistance R <sub>1</sub>	2.6 mΩ
Contact resistance R <sub>2</sub>	2.6 mΩ
Insertion/withdrawal cycles	25

### Climatic test

Specification	ISO 6988:1985-02
Corrosive stress	0.2 dm <sup>3</sup> SO <sub>2</sub> on 300 dm <sup>3</sup> /40 °C/1 cycle
Thermal stress	105 °C/168 h
Power-frequency withstand voltage	1.39 kV

### Vibration test

Specification	IEC 60068-2-6:2007-12
---------------	-----------------------

# DD21H 0,85/ 8-PT-2,5-Y - Feed-through plug



1378115

<https://www.phoenixcontact.com/us/products/1378115>

Frequency	10 - 150 - 10 Hz
Sweep speed	1 octave/min
Amplitude	0.35 mm (10 Hz ... 60.1 Hz)
Acceleration	50 m/s <sup>2</sup> (60.1 Hz ... 150 Hz)
Test duration per axis	2.5 h
Test directions	X-, Y- and Z-axis

## Shocks

Specification	IEC 60068-2-27:2008-02
Pulse shape	Half-sine
Acceleration	30g
Shock duration	11 ms
Test directions	X-, Y- and Z-axis (pos. and neg.)

## Ambient conditions

Ambient temperature (storage/transport)	-40 °C ... 70 °C
Relative humidity (storage/transport)	30 % ... 70 %
Ambient temperature (assembly)	-5 °C ... 100 °C
Ambient temperature (operation)	-55 °C ... 105 °C (dependent on the derating curve)

## Ambient conditions

Ambient temperature (operation)	-55 °C ... 105 °C (dependent on the derating curve)
Ambient temperature (storage/transport)	-40 °C ... 70 °C
Relative humidity (storage/transport)	30 % ... 70 %
Ambient temperature (assembly)	-5 °C ... 100 °C

## Packaging specifications

Type of packaging	packed in cardboard
-------------------	---------------------

# DD21H 0,85/ 8-PT-2,5-Y - Feed-through plug



1378115

<https://www.phoenixcontact.com/us/products/1378115>

## Drawings



Type: DD21PC 0,85/...-2,5-Y with DD21H 0,85/...-PT-2,5-Y

# DD21H 0,85/ 8-PT-2,5-Y - Feed-through plug



1378115

<https://www.phoenixcontact.com/us/products/1378115>

## Approvals

To download certificates, visit the product detail page: <https://www.phoenixcontact.com/us/products/1378115>

 <b>UL Recognized</b> Approval ID: E118976-20240611				
	Nominal voltage $U_N$	Nominal current $I_N$	Cross section AWG	Cross section $\text{mm}^2$
keine				
	125 V	5 A	18	-

# DD21H 0,85/ 8-PT-2,5-Y - Feed-through plug



1378115

<https://www.phoenixcontact.com/us/products/1378115>

## Classifications

### ECLASS

ECLASS-13.0	27460202
ECLASS-15.0	27460202

### ETIM

ETIM 10.0	EC002638
-----------	----------

### UNSPSC

UNSPSC 21.0	39121400
-------------	----------

# DD21H 0,85/ 8-PT-2,5-Y - Feed-through plug



1378115

<https://www.phoenixcontact.com/us/products/1378115>

## Environmental product compliance

### EU RoHS

Fulfills EU RoHS substance requirements	Yes, No exemptions
---	--------------------

### China RoHS

Environment friendly use period (EFUP)	EFUP-E
	No hazardous substances above the limits

### EU REACH SVHC

REACH candidate substance (CAS No.)	No substance above 0.1 wt%
-------------------------------------	----------------------------

### EF3.1 Climate Change

CO2e kg	0.049 kg CO2e
---------	---------------

Phoenix Contact 2026 © - all rights reserved  
<https://www.phoenixcontact.com>

Phoenix Contact USA  
586 Fulling Mill Road  
Middletown, PA 17057, United States  
(+717) 944-1300  
[info@phoenixcon.com](mailto:info@phoenixcon.com)