

HC-STA-B16-BWD-EL/.../... - Housing

1373288

<https://www.phoenixcontact.com/us/products/1373288>

Please be informed that the data shown in this PDF document is generated from our online catalog. Please find the complete data in the user documentation. Our general terms of use for downloads are valid.



Panel mounting base B16, with double locking latch, material: Die-cast aluminum, salt water resistant, height: 30.5 mm, cable gland: none

Commercial data

Item number	1373288
Packing unit	1 pc
Minimum order quantity	1 pc
Note	Made to order (non-returnable)
Sales key	BF71
Product key	AF7APB
Weight per piece (including packing)	117 g
Weight per piece (excluding packing)	117 g
Customs tariff number	85389099
Country of origin	PL

HC-STA-B16-BWD-EL/.../... - Housing

1373288

<https://www.phoenixcontact.com/us/products/1373288>

Technical data

Product properties

Product type	Housing with locking latch
Housing type	Panel mounting base
Application	Standard
Design	B16
Type of locking	with double locking latch

Dimensions

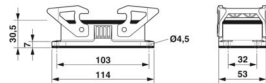
Dimensional drawing	
Width	53 mm
Height	30.5 mm
Length	114 mm

Material specifications

Color	black (RAL 9005)
Flammability rating according to UL 94	V0 (Interlock)
Housing material	Die-cast aluminum, salt water resistant
Housing surface material	uncoated
Locking latch material	Polyamide

Environmental and real-life conditions

Ambient conditions

Degree of protection	IP66 IP67
Enclosure rating (NEMA)	4 (UL 50e) 4X (UL 50e) 12 (UL 50e)
Impact strength	IK09
Ambient temperature (operation)	-40 °C ... 125 °C

HC-STA-B16-BWD-EL/.../... - Housing



1373288

<https://www.phoenixcontact.com/us/products/1373288>

Drawings

Dimensional drawing

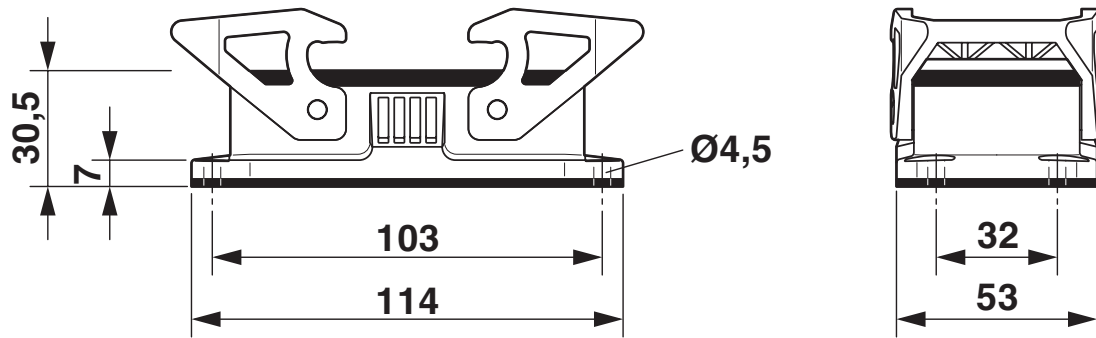





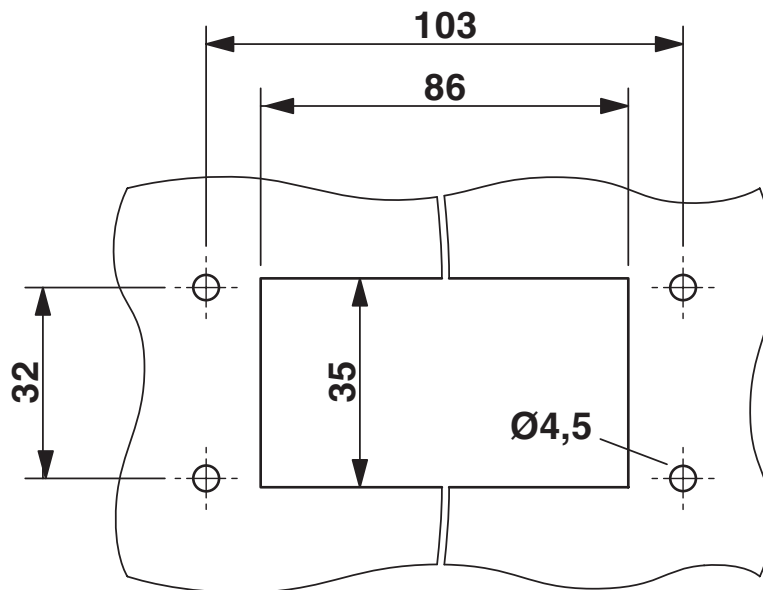





Dimensional drawing

Dimensional drawing



Mounting cutout

Application drawing

	YE – RAL 1021		WH – RAL 9016
	RD – RAL 3020		VT – RAL 4004
	GY – RAL 7045		GN – RAL 6005
	PL – RAL 4006		BN – RAL 8017
	BK – RAL 9005		OG – RAL 2004
	BU – RAL 5005		

HC-STA-B16-BWD-EL/.../... - Housing



1373288

<https://www.phoenixcontact.com/us/products/1373288>

Approvals

To download certificates, visit the product detail page: <https://www.phoenixcontact.com/us/products/1373288>



cUL Recognized
Approval ID: E255026



UL Recognized
Approval ID: E255026

1373288

<https://www.phoenixcontact.com/us/products/1373288>

Classifications

ECLASS

ECLASS-13.0	27440202
ECLASS-15.0	27440202

ETIM

ETIM 10.0	EC000437
-----------	----------

UNSPSC

UNSPSC 21.0	31261500
-------------	----------

HC-STA-B16-BWD-EL/.../... - Housing



1373288

<https://www.phoenixcontact.com/us/products/1373288>

Environmental product compliance

EU RoHS

Fulfills EU RoHS substance requirements	Yes, No exemptions
---	--------------------

China RoHS

Environment friendly use period (EFUP)	EFUP-E
	No hazardous substances above the limits

EU REACH SVHC

REACH candidate substance (CAS No.)	No substance above 0.1 wt%
-------------------------------------	----------------------------

Phoenix Contact 2026 © - all rights reserved
<https://www.phoenixcontact.com>

Phoenix Contact USA
586 Fulling Mill Road
Middletown, PA 17057, United States
(+717) 944-1300
info@phoenixcon.com