

HC-B24-BCFS-P-BK - Protective cover



1346545

<https://www.phoenixcontact.com/us/products/1346545>

Please be informed that the data shown in this PDF document is generated from our online catalog. Please find the complete data in the user documentation. Our general terms of use for downloads are valid.



Protective cover B24, for single locking latch, protective cover material: PC, height: 26.3 mm, seal: no

Commercial data

Item number	1346545
Packing unit	1 pc
Minimum order quantity	1 pc
Sales key	BF66
Product key	AF7AZC
GTIN	4063151660642
Weight per piece (including packing)	33.5 g
Weight per piece (excluding packing)	34.5 g
Customs tariff number	85389099
Country of origin	CN

HC-B24-BCFS-P-BK - Protective cover

1346545

<https://www.phoenixcontact.com/us/products/1346545>

Technical data

Product properties

Product type	Protective cover
Housing type	Protective cover
Type	B24
Retaining cord present	yes
Seal present	no

Dimensions

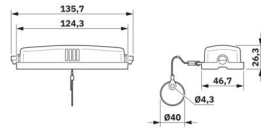
Dimensional drawing	
Width	46.7 mm
Height	26.3 mm
Length	124.3 mm
Diameter	40 mm

Material specifications

Material Protective cover	PC
Flammability rating according to UL 94	V0
Material, protective cover	PC

Environmental and real-life conditions

Ambient conditions

Degree of protection	IP66
Ambient temperature (operation)	-40 °C ... 125 °C
Resistance to UV radiation	yes

Mounting

Assembly note	Double eyelet for mounting on a cable / below screw head
	Plastic protective cover for short-term protection

HC-B24-BCFS-P-BK - Protective cover

1346545

<https://www.phoenixcontact.com/us/products/1346545>

Drawings

Dimensional drawing

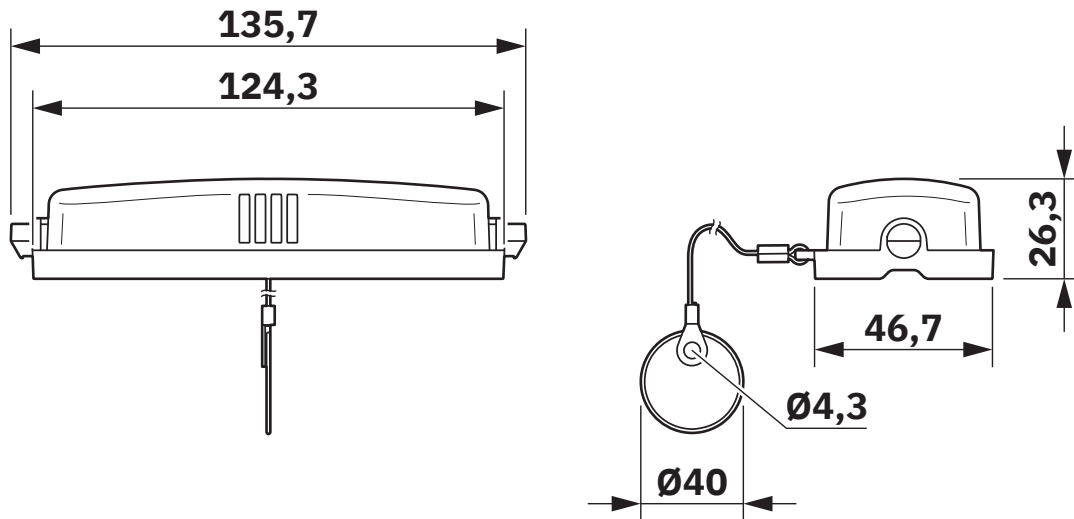

Dimensional drawing

HC-B24-BCFS-P-BK - Protective cover



1346545

<https://www.phoenixcontact.com/us/products/1346545>

Approvals

🔗 To download certificates, visit the product detail page: <https://www.phoenixcontact.com/us/products/1346545>

DNV

Approval ID: TAE000037S

HC-B24-BCFS-P-BK - Protective cover



1346545

<https://www.phoenixcontact.com/us/products/1346545>

Classifications

ECLASS

ECLASS-13.0	27440208
ECLASS-15.0	27440208

ETIM

ETIM 10.0	EC002314
-----------	----------

UNSPSC

UNSPSC 21.0	39121400
-------------	----------

HC-B24-BCFS-P-BK - Protective cover



1346545

<https://www.phoenixcontact.com/us/products/1346545>

Environmental product compliance

EU RoHS

Fulfills EU RoHS substance requirements	Yes, No exemptions
---	--------------------

China RoHS

Environment friendly use period (EFUP)	EFUP-E
	No hazardous substances above the limits

EU REACH SVHC

REACH candidate substance (CAS No.)	No substance above 0.1 wt%
-------------------------------------	----------------------------

Phoenix Contact 2026 © - all rights reserved
<https://www.phoenixcontact.com>

Phoenix Contact USA
586 Fulling Mill Road
Middletown, PA 17057, United States
(+717) 944-1300
info@phoenixcon.com