

FR 1,27/ 26-FH - SMD female connectors



1337013

<https://www.phoenixcontact.com/us/products/1337013>

Please be informed that the data shown in this PDF document is generated from our online catalog. Please find the complete data in the user documentation. Our general terms of use for downloads are valid.



SMD female connector, nominal current: 2.2 A, test voltage: 500 V AC, number of positions: 26, pitch: 1.27 mm, color: black, contact surface: Au, contact connection type: Socket, mounting: SMD soldering



Your advantages

- The first high-speed data transmission at up to 28 Gbps using the established market standard, opens up new design possibilities.
- Robust 6-pos. to 100-pos. board-to-board and wire-to-board connectors ensure greater flexibility with regard to component options.
- Time savings during the development process with customer-specific simulations for data integrity
- Gold-plated contact points enable long-term stable signal transmission and currents of up to 2.3 A.
- Design-in support during device development using MCAD/ECAD data and a free sample service

Commercial data

Item number	1337013
Packing unit	560 pc
Minimum order quantity	560 pc
Sales key	AA24
Product key	AAXAAA
GTIN	4063151638078
Weight per piece (including packing)	1.86 g
Weight per piece (excluding packing)	0.97 g
Customs tariff number	85366930
Country of origin	CN

1337013

<https://www.phoenixcontact.com/us/products/1337013>

Technical data

Product properties

Product type	SMD female connector
Product family	FR 1,27/...-FH
Number of positions	26
Pitch	1.27 mm
Number of rows	2
Pin layout	Linear pad geometry

Electrical properties

Properties

Nominal current I_N	2.2 A IEC 60512-5-2:2002-02 (at 20°C 100-pos.)
Contact resistance	10 mΩ
Test voltage	500 V AC IEC 60512-4-1:2003-05

Data transmission

Data transmission rate	12 Gbps
------------------------	---------

Mounting

Mounting type	SMD soldering
Pin layout	Linear pad geometry

Processing notes

Process	Reflow soldering
Moisture Sensitive Level	MSL 1
Classification temperature T_C	260 °C
Solder cycles in the reflow	3

Material specifications

Material data - contact

Note	WEEE/RoHS-compliant, free of whiskers according to IEC 60068-2-82/JEDEC JESD 201
Contact material	Cu alloy
Surface characteristics	Selective coating
Metal surface contact area (top layer)	Gold (min. 0.5 μm Au)
Metal surface contact area (middle layer)	Nickel (1.27 μm - 4 μm Ni)
Metal surface soldering area (top layer)	Tin (3 μm - 6 μm Sn)
Metal surface soldering area (middle layer)	Nickel (1.27 μm - 4 μm Ni)

Material data - housing

Color (Housing)	black (9005)
Insulating material	LCP
Insulating material group	IIIb

FR 1,27/ 26-FH - SMD female connectors

1337013

<https://www.phoenixcontact.com/us/products/1337013>

CTI according to IEC 60112	150
Flammability rating according to UL 94	V0

Notes

Notes on operation	The permissible voltage during operation depends on the application, taking into consideration the air clearances and creepage distances within the scope of insulation requirements in accordance with IEC 60664-1.
--------------------	--

Dimensions

Dimensional drawing	
Pitch	1.27 mm
Width [w]	21.6 mm
Height [h]	4.53 mm
Length [l]	10.8 mm
Installed height	3.78 mm

Application

Contact cover	0.9 mm
Center offset	± 0.7 mm in longitudinal and transverse direction
Wipe length	1.5 mm
Angular tolerance	± 5 ° in longitudinal and transverse direction

PCB design

Pad geometry	0.8 x 0.8 mm
--------------	--------------

Electrical tests

Thermal test | Test group C

Specification	IEC 60512-5-2:2002-02
---------------	-----------------------

Insulation resistance

Specification	IEC 60512-3-1:2002-02
Insulation resistance, neighboring positions	≥ 5 GΩ

Air clearances and creepage distances |

Insulating material group	IIIb
Minimum value for clearance and creepage distance	0.4 mm

Environmental and real-life conditions

Durability test

Specification	IEC 60512-9-1:2010-03 (following)
---------------	-----------------------------------

FR 1,27/ 26-FH - SMD female connectors



1337013

<https://www.phoenixcontact.com/us/products/1337013>

Contact resistance R_1	10 m Ω
Contact resistance R_2	15 m Ω
Insertion/withdrawal cycles	500
Insulation resistance, neighboring positions	$\geq 5 \text{ G}\Omega$

Vibration test

Specification	IEC 60068-2-6:2007-12
Frequency	10 - 2000 - 10 Hz
Sweep speed	1 octave/min
Amplitude	1.5 mm (10 Hz ... 58 Hz)
Acceleration	200 m/s ² (58 Hz ... 2000 Hz)
Test duration per axis	2.5 h
Test directions	X-, Y- and Z-axis

Shocks

Specification	IEC 60068-2-27:2008-02
Pulse shape	Semi-sinusoidal
Acceleration	490 m/s ²
Shock duration	11 ms
Test directions	X-, Y- and Z-axis (pos. and neg.)

Railway application: Oscillation/broadband noise

Specification	DIN EN 50155 (VDE 0115-200):2022-06
	IEC 61373:2010-05
Spectrum	Long life test category 2, bogie-mounted
Frequency	$f_1 = 5 \text{ Hz}$ to $f_2 = 250 \text{ Hz}$
ASD level	6.12 (m/s ²) ² /Hz
Acceleration	30.6 m/s ²
Test duration per axis	5 h
Test directions	X-, Y- and Z-axis
Contact interruption	< 1 μs
Result	Test passed

Railway application: Shocks

Specification	DIN EN 50155 (VDE 0115-200):2022-06
	IEC 61373:2010-05
Pulse shape	Semi-sinusoidal
Acceleration	490 m/s ²
Shock duration	11 ms
Number of shocks per direction	3
Test directions	X-, Y- and Z-axis (pos. and neg.)
Contact interruption	< 1 μs
Result	Test passed

Ambient conditions

Ambient temperature (storage/transport)	-40 °C ... 70 °C
---	------------------

FR 1,27/ 26-FH - SMD female connectors

1337013

<https://www.phoenixcontact.com/us/products/1337013>

Relative humidity (storage/transport)	30 % ... 70 %
Ambient temperature (assembly)	-5 °C ... 100 °C
Ambient temperature (operation)	-55 °C ... 125 °C

Packaging specifications

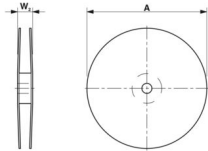
Dimensional drawing	
Type of packaging	44 mm wide tape
[W] tape width	44 mm
[W2] coil overall dimension	≤ 50.4 mm
[A] coil diameter	≤ 330 mm
Outer packaging type	Transparent-Bag

Drawings

Diagram



Type: FR 1,27/...-FH with FR 1,27/...-MV 3,25

Diagram



Type: FR 1,27/...-FH with FR 1,27/...-MH

FR 1,27/ 26-FH - SMD female connectors



1337013

<https://www.phoenixcontact.com/us/products/1337013>

Approvals

To download certificates, visit the product detail page: <https://www.phoenixcontact.com/us/products/1337013>

 cUL Recognized Approval ID: E118976-20230317				
	Nominal voltage U_N	Nominal current I_N	Cross section AWG	Cross section mm^2
keine				
	29.9 V	1.4 A	-	-

 UL Recognized Approval ID: E118976-20230317				
	Nominal voltage U_N	Nominal current I_N	Cross section AWG	Cross section mm^2
keine				
	29.9 V	2 A	-	-

FR 1,27/ 26-FH - SMD female connectors



1337013

<https://www.phoenixcontact.com/us/products/1337013>

Classifications

ECLASS

ECLASS-13.0	27460201
ECLASS-15.0	27460201

ETIM

ETIM 10.0	EC002637
-----------	----------

UNSPSC

UNSPSC 21.0	39121400
-------------	----------

FR 1,27/ 26-FH - SMD female connectors



1337013

<https://www.phoenixcontact.com/us/products/1337013>

Environmental product compliance

EU RoHS

Fulfills EU RoHS substance requirements	Yes, No exemptions
---	--------------------

China RoHS

Environment friendly use period (EFUP)	EFUP-E
	No hazardous substances above the limits

EU REACH SVHC

REACH candidate substance (CAS No.)	No substance above 0.1 wt%
-------------------------------------	----------------------------

Phoenix Contact 2026 © - all rights reserved
<https://www.phoenixcontact.com>

Phoenix Contact USA
586 Fulling Mill Road
Middletown, PA 17057, United States
(+717) 944-1300
info@phoenixcon.com