

# MSTBT 2,5 HC/ 4-STPKMGYTP37-40 - PCB connector



1204401

<https://www.phoenixcontact.com/us/products/1204401>

Please be informed that the data shown in this PDF document is generated from our online catalog. Please find the complete data in the user documentation. Our general terms of use for downloads are valid.



The figure shows the standard item without printing

PCB connector, nominal cross section: 2.5 mm<sup>2</sup>, color: light gray, nominal current: 16 A (see derating curve), rated voltage (III/2): 320 V, contact surface: Sn, contact connection type: Socket, number of potentials: 4, number of rows: 1, number of positions: 4, number of connections: 4, product range: MSTBT 2,5 HC/..-STP, pitch: 5 mm, connection method: Screw connection with tension sleeve, conductor/PCB connection direction: 0 °, locking clip: - Locking clip, plug-in system: COMBICON MSTB 2,5 advanced, locking: without, mounting method: without, type of packaging: packed in cardboard, Printed version

## Your advantages

- Orthogonal plug-in screw connection
- Internationally recognized and proven screw connection

## Commercial data

Item number	1204401
Packing unit	50 pc
Minimum order quantity	250 pc
Note	Made to order (non-returnable)
Product key	ACHADB
GTIN	4063151273118
Weight per piece (including packing)	6.618 g
Weight per piece (excluding packing)	6.618 g
Country of origin	DE

# MSTBT 2,5 HC/ 4-STPKMGYTP37-40 - PCB connector



1204401

<https://www.phoenixcontact.com/us/products/1204401>

## Technical data

### Product properties

Product type	PCB connector
Product family	MSTBT 2,5 HC/..-STP
Product line	COMBICON Connectors M
Type	Standard
Number of positions	4
Pitch	5 mm
Number of connections	4
Number of rows	1
Number of potentials	4

### Electrical properties

#### Properties

Nominal current $I_N$	16 A (see derating curve)
Nominal voltage $U_N$	250 V
Contact resistance	1.2 m $\Omega$
Rated voltage (III/3)	250 V
Rated surge voltage (III/3)	4 kV
Rated voltage (III/2)	320 V
Rated surge voltage (III/2)	4 kV
Rated voltage (II/2)	630 V
Rated surge voltage (II/2)	4 kV

### Connection data

#### Connection technology

Type	Standard
Connector system	COMBICON MSTB 2,5 advanced
Nominal cross section	2.5 mm <sup>2</sup>
Contact connection type	Socket

#### Interlock

Locking type	without
Mounting type	without

#### Conductor connection

Connection method	Screw connection with tension sleeve
Conductor/PCB connection direction	0 °
Conductor cross-section rigid	0.2 mm <sup>2</sup> ... 2.5 mm <sup>2</sup>
Conductor cross-section flexible	0.2 mm <sup>2</sup> ... 2.5 mm <sup>2</sup>
Conductor cross-section AWG	24 ... 12
Conductor cross-section, flexible, with ferrule, without plastic sleeve	0.25 mm <sup>2</sup> ... 2.5 mm <sup>2</sup>

# MSTBT 2,5 HC/ 4-STPKMGYTP37-40 - PCB connector



1204401

<https://www.phoenixcontact.com/us/products/1204401>

Conductor cross-section, flexible, with ferrule, with plastic sleeve	0.25 mm <sup>2</sup> ... 2.5 mm <sup>2</sup>
2 conductors with same cross section, rigid	0.2 mm <sup>2</sup> ... 1 mm <sup>2</sup>
2 conductors with same cross section, flexible	0.2 mm <sup>2</sup> ... 1.5 mm <sup>2</sup>
2 conductors with same cross section, flexible, with ferrule without plastic sleeve	0.25 mm <sup>2</sup> ... 1 mm <sup>2</sup>
2 conductors with the same cross section, flexible, with TWIN ferrule with plastic sleeve	0.5 mm <sup>2</sup> ... 1.5 mm <sup>2</sup>
Cylindrical gauge a x b / diameter	2.8 mm x 2.0 mm / 2.4 mm
Stripping length	7 mm
Tightening torque	0.5 Nm ... 0.6 Nm

## Material specifications

### Material data - contact

Note	WEEE/RoHS-compliant, free of whiskers according to IEC 60068-2-82/JEDEC JESD 201
Contact material	Cu alloy
Surface characteristics	hot-dip tin-plated
Metal surface terminal point (top layer)	Tin (4 µm - 8 µm Sn)
Metal surface contact area (top layer)	Tin (4 µm - 8 µm Sn)

### Material data - housing

Color (Housing)	light gray (7035)
Insulating material	PA
Insulating material group	I
CTI according to IEC 60112	600
Flammability rating according to UL 94	V0
Glow wire flammability index GWFI according to EN 60695-2-12	850
Glow wire ignition temperature GWIT according to EN 60695-2-13	775
Temperature for the ball pressure test according to EN 60695-10-2	125 °C

## Dimensions

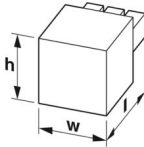
Dimensional drawing	
Pitch	5 mm
Width [w]	20 mm
Height [h]	15 mm
Length [l]	18.1 mm

## Notes

# MSTBT 2,5 HC/ 4-STPKMGYTP37-40 - PCB connector



1204401

<https://www.phoenixcontact.com/us/products/1204401>

Notes on operation	In accordance with IEC 61984, COMBICON connectors have no switching power (COC). During designated use, they must not be plugged in or disconnected when carrying voltage or under load.
--------------------	--

## Safety note

Safety note	WARNING: The connectors may not be plugged in or disconnected under load. Ignoring the warning or improper use may damage persons and/or property.
	<ul style="list-style-type: none"> <li>• WARNING: Commission properly functioning products only. The products must be regularly inspected for damage. Decommission defective products immediately. Replace damaged products. Repairs are not possible.</li> </ul>
	<ul style="list-style-type: none"> <li>• WARNING: Only electrically qualified personnel may install and operate the product. They must observe the following safety notes. The qualified personnel must be familiar with the basics of electrical engineering. They must be able to recognize and prevent danger. The relevant symbol on the packaging indicates that only personnel familiar with electrical engineering are allowed to install and operate the product.</li> </ul>
	<ul style="list-style-type: none"> <li>• The item is intended to be an unencapsulated plug for installation in a housing.</li> <li>• Operate the connector only when it is fully plugged in.</li> </ul>

## Mechanical tests

### Test for conductor damage and slackening

Specification	IEC 60999-1:1999-11
Result	Test passed

### Pull-out test

Specification	IEC 60999-1:1999-11
Conductor cross-section/conductor type/tractive force setpoint/actual value	0.2 mm <sup>2</sup> / solid / > 10 N
	0.2 mm <sup>2</sup> / flexible / > 10 N
	2.5 mm <sup>2</sup> / solid / > 50 N
	2.5 mm <sup>2</sup> / flexible / > 50 N

### Insertion and withdrawal forces

Specification	IEC 60512-13-2:2006-02
Result	Test passed
No. of cycles	25
Insertion strength per pos. approx.	11 N
Withdraw strength per pos. approx.	7 N

### Torque test

Specification	IEC 60999-1:1999-11
---------------	---------------------

### Resistance of inscriptions

Specification	IEC 60068-2-70:1995-12
Result	Test passed

### Polarization and coding

# MSTBT 2,5 HC/ 4-STPKMGYTP37-40 - PCB connector



1204401

<https://www.phoenixcontact.com/us/products/1204401>

Specification	IEC 60512-13-5:2006-02
Result	Test passed

## Visual inspection

Specification	IEC 60512-1-1:2002-02
Result	Test passed

## Dimension check

Specification	IEC 60512-1-2:2002-02
Result	Test passed

## Environmental and real-life conditions

### Durability test

Specification	IEC 60512-9-1:2010-03
Impulse withstand voltage at sea level	4.8 kV
Contact resistance $R_1$	1.2 m $\Omega$
Contact resistance $R_2$	1.23 m $\Omega$
Insertion/withdrawal cycles	25
Insulation resistance, neighboring positions	> 21 T $\Omega$

### Climatic test

Specification	ISO 6988:1985-02
Corrosive stress	1.0 dm <sup>3</sup> SO <sub>2</sub> on 300 dm <sup>3</sup> /40 °C/3 cycles
Thermal stress	100 °C/168 h
Power-frequency withstand voltage	3.1 kV

### Vibration test

Specification	IEC 60068-2-6:2007-12
Frequency	10 - 150 - 10 Hz
Sweep speed	1 octave/min
Amplitude	0.35 mm (10 Hz ... 60.1 Hz)
Acceleration	5g (60.1 Hz ... 150 Hz)
Test duration per axis	2.5 h
Test directions	X-, Y- and Z-axis

### Ambient conditions

Ambient temperature (storage/transport)	-40 °C ... 55 °C
Relative humidity (storage/transport)	30 % ... 70 %
Ambient temperature (assembly)	-5 °C ... 100 °C
Ambient temperature (operation)	-40 °C ... 105 °C (dependent on the derating curve)

## Electrical tests

### Thermal test | Test group C

Specification	IEC 60512-5-1:2002-02
Tested number of positions	4

# MSTBT 2,5 HC/ 4-STPKMGYTP37-40 - PCB connector



1204401

<https://www.phoenixcontact.com/us/products/1204401>

## Insulation resistance

Specification	IEC 60512-3-1:2002-02
Insulation resistance, neighboring positions	> 21 TΩ

## Air clearances and creepage distances |

Specification	IEC 60664-1:2007-04
Insulating material group	I
Comparative tracking index (IEC 60112)	CTI 600
Rated insulation voltage (III/3)	250 V
Rated surge voltage (III/3)	4 kV
minimum clearance value - non-homogenous field (III/3)	3 mm
minimum creepage distance (III/3)	3.2 mm
Rated insulation voltage (III/2)	320 V
Rated surge voltage (III/2)	4 kV
minimum clearance value - non-homogenous field (III/2)	3 mm
minimum creepage distance (III/2)	1.6 mm
Rated insulation voltage (II/2)	630 V
Rated surge voltage (II/2)	4 kV
minimum clearance value - non-homogenous field (II/2)	3 mm
minimum creepage distance (II/2)	3.2 mm

## Packaging specifications

Type of packaging	packed in cardboard
-------------------	---------------------

# MSTBT 2,5 HC/ 4-STPKMGYTP37-40 - PCB connector



1204401

<https://www.phoenixcontact.com/us/products/1204401>

## Drawings

Diagram

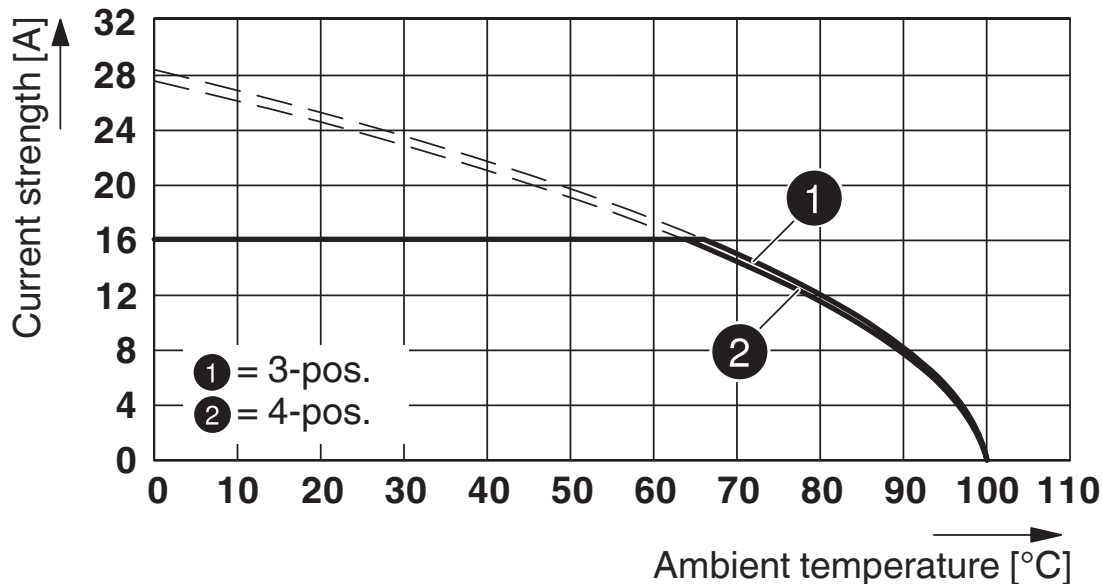

Type: MSTBT 2,5 HC/...-STF with ICC20(25)-H/...L(R)5,0-...

Diagram



Derating curve for: MSTBT 2,5 HC/...-STP GY7035 with MSTBO 2,5/...-G1PL(R) GY7035

# MSTBT 2,5 HC/ 4-STPKMGYTP37-40 - PCB connector



1204401

<https://www.phoenixcontact.com/us/products/1204401>



Derating curve for: MSTBT 2,5 HC/...-STP GY7035 with MSTBO 2,5/...-G1PL(R) GY7035

# MSTBT 2,5 HC/ 4-STPKMGYTP37-40 - PCB connector



1204401

<https://www.phoenixcontact.com/us/products/1204401>

## Approvals

To download certificates, visit the product detail page: <https://www.phoenixcontact.com/us/products/1204401>

 <b>cULus Recognized</b> Approval ID: E60425-19931011		Nominal voltage $U_N$	Nominal current $I_N$	Cross section AWG	Cross section $\text{mm}^2$
B		300 V	16 A	30 - 12	-

# MSTBT 2,5 HC/ 4-STPKMGYTP37-40 - PCB connector



1204401

<https://www.phoenixcontact.com/us/products/1204401>

## Classifications

### ECLASS

ECLASS-13.0	27460202
ECLASS-15.0	27460202

### ETIM

ETIM 10.0	EC002638
-----------	----------

### UNSPSC

UNSPSC 21.0	39121400
-------------	----------

# MSTBT 2,5 HC/ 4-STPKMGYTP37-40 - PCB connector



1204401

<https://www.phoenixcontact.com/us/products/1204401>

## Environmental product compliance

### EU RoHS

Fulfills EU RoHS substance requirements	Yes, No exemptions
---	--------------------

### China RoHS

Environment friendly use period (EFUP)	EFUP-E
	No hazardous substances above the limits

### EU REACH SVHC

REACH candidate substance (CAS No.)	No substance above 0.1 wt%
-------------------------------------	----------------------------

### EF3.1 Climate Change

CO2e kg	0.035 kg CO2e
---------	---------------

Phoenix Contact 2026 © - all rights reserved  
<https://www.phoenixcontact.com>

Phoenix Contact USA  
586 Fulling Mill Road  
Middletown, PA 17057, United States  
(+717) 944-1300  
[info@phoenixcon.com](mailto:info@phoenixcon.com)