

# SAC-5PY-FK/MK-FK F VP SH - Y distributor



1080247

<https://www.phoenixcontact.com/us/products/1080247>

Please be informed that the data shown in this PDF document is generated from our online catalog. Please find the complete data in the user documentation. Our general terms of use for downloads are valid.

Y distributor, 5-position, shielded, Plug straight M12, coding: K, on Socket straight M12, coding: K and Socket straight M12, coding: K, for alternating current up to 16 A/630 V, Parallel distributor



## Your advantages

- High-performance: AC connectors for up to 16 A and 630 V AC

## Commercial data

Item number	1080247
Packing unit	1 pc
Minimum order quantity	1 pc
Sales key	BF10
Product key	AF1GAP
GTIN	4055626802800
Weight per piece (including packing)	96.5 g
Weight per piece (excluding packing)	96.5 g
Customs tariff number	85366990
Country of origin	DE

## Technical data

### Notes

Assembly note	<b>NOTE:</b> Observe the permissible bending radii when routing cables, since the degree of protection may be at risk if the bending forces are too high. Reduce mechanical loads upstream of the connector, e.g., by using cable ties.
---------------	---

### Product properties

Product type	Y-distributor
Application	Energy supply
Number of positions	5
No. of cable outlets	2
Shielded	yes
Coding	K
Thread type	M12

### Insulation characteristics

Overvoltage category	III
Degree of pollution	3

### Electrical properties

Nominal voltage $U_N$	630 V AC
Nominal current $I_N$	16 A (at 40 °C)

### Signaling

Status display	no
Status display present	no

### Dimensions

Dimensional drawing	
Width	28 mm
Height	47 mm
Length	62.5 mm
Center distance	35 mm

### Material specifications

Material	CuZn (Pin contact) (Female contact)
Flammability rating according to UL 94	V0

# SAC-5PY-FK/MK-FK F VP SH - Y distributor



1080247

<https://www.phoenixcontact.com/us/products/1080247>

Seal material	HNBR
Material of grip body	PBT
Contact surface material	Au
Contact carrier material	PBT
Material for screw connection	Brass, nickel-plated

## Connector

### Connection 1

Type	Plug straight M12
Coding type	K

### Connection 2

Type	Socket straight M12
Coding type	K

### Connection 3

Type	Socket straight M12
Coding type	K

## Mechanical properties

### Mechanical data

Insertion/withdrawal cycles	> 100
-----------------------------	-------

## Environmental and real-life conditions

### Ambient conditions

Degree of protection	IP65
Ambient temperature (operation)	-40 °C ... 85 °C (Plug / socket)

## Standards and regulations

Standard designation	M12 connector
Standards/specifications	IEC 61076-2-111

# SAC-5PY-FK/MK-FK F VP SH - Y distributor

1080247

<https://www.phoenixcontact.com/us/products/1080247>

## Drawings

Dimensional drawing

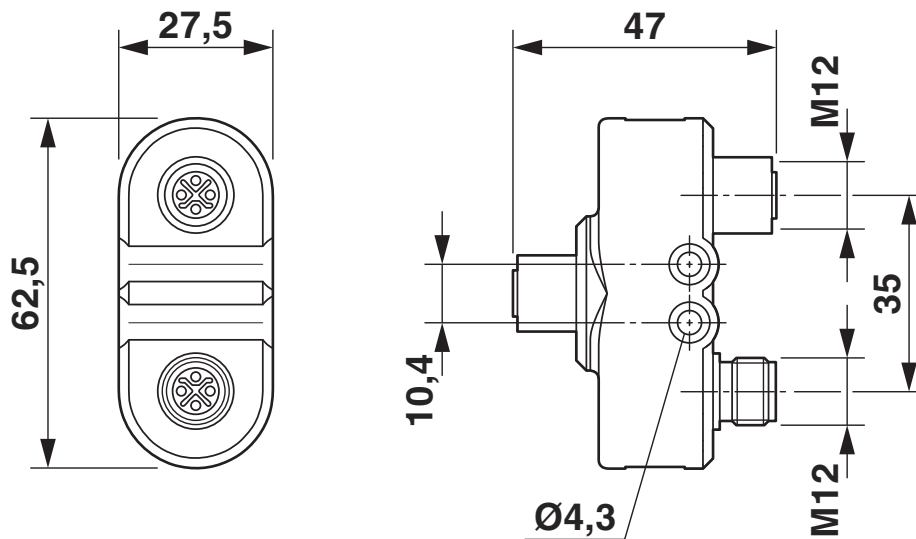

M12 Y distributor

Schematic diagram

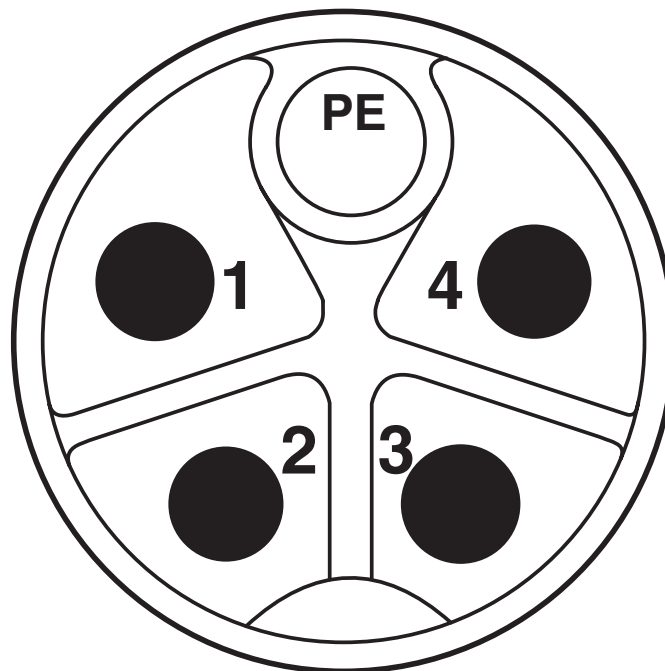

Pin assignment of M12 male connector, 4-pos.+PE, K-coded, view of pin side

# SAC-5PY-FK/MK-FK F VP SH - Y distributor

1080247

<https://www.phoenixcontact.com/us/products/1080247>

Schematic diagram

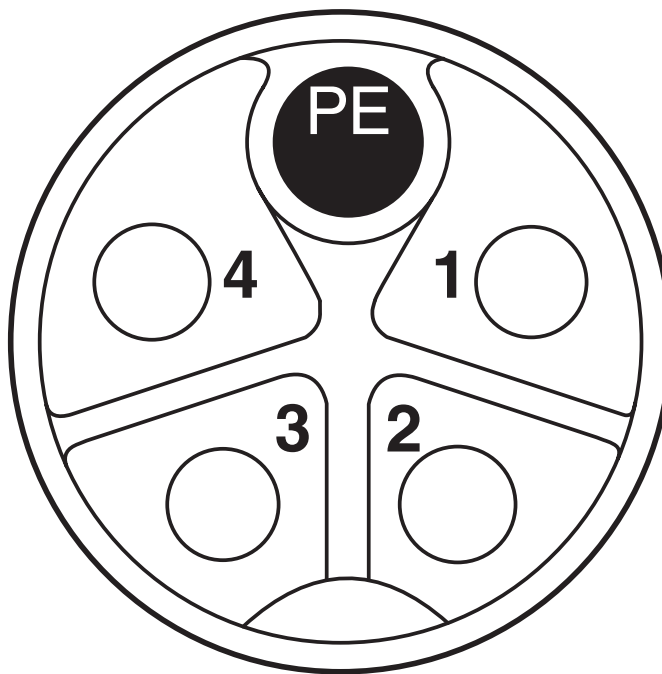

Pin assignment of M12 socket, 4-pos.+PE, K-coded, socket side view

Diagram

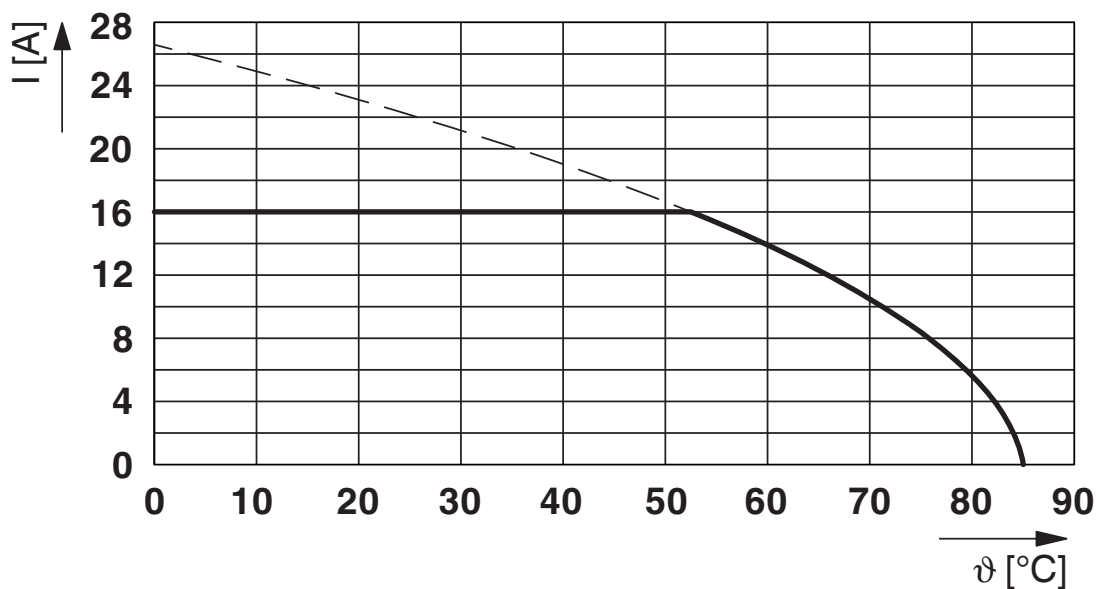

Current carrying capacity

# SAC-5PY-FK/MK-FK F VP SH - Y distributor

1080247

<https://www.phoenixcontact.com/us/products/1080247>



Circuit diagram

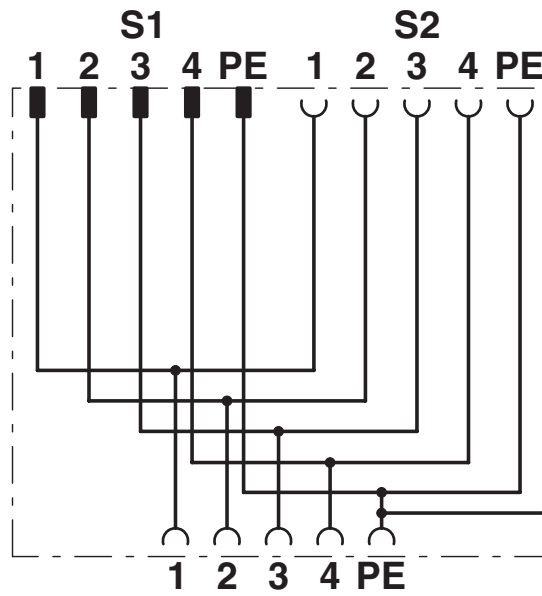

Contact assignment of the M12 Y distributor

# SAC-5PY-FK/MK-FK F VP SH - Y distributor





1080247

<https://www.phoenixcontact.com/us/products/1080247>

## Approvals

To download certificates, visit the product detail page: <https://www.phoenixcontact.com/us/products/1080247>

 <b>UL Listed</b> Approval ID: E468743				
	Nominal voltage $U_N$	Nominal current $I_N$	Cross section AWG	Cross section $\text{mm}^2$
keine				
for AC application only	600 V	16 A	-	-

 <b>cUL Listed</b> Approval ID: E468743				
	Nominal voltage $U_N$	Nominal current $I_N$	Cross section AWG	Cross section $\text{mm}^2$
keine				
for AC application only	600 V	15 A	-	-

# SAC-5PY-FK/MK-FK F VP SH - Y distributor



1080247

<https://www.phoenixcontact.com/us/products/1080247>

## Classifications

### ECLASS

ECLASS-13.0	27440106
ECLASS-15.0	27440106

### ETIM

ETIM 10.0	EC002925
-----------	----------

### UNSPSC

UNSPSC 21.0	31251500
-------------	----------

# SAC-5PY-FK/MK-FK F VP SH - Y distributor



1080247

<https://www.phoenixcontact.com/us/products/1080247>

## Environmental product compliance

### EU RoHS

Fulfills EU RoHS substance requirements	Yes, No exemptions
---	--------------------

### China RoHS

Environment friendly use period (EFUP)	EFUP-E
	No hazardous substances above the limits

### EU REACH SVHC

REACH candidate substance (CAS No.)	No substance above 0.1 wt%
-------------------------------------	----------------------------

Phoenix Contact 2026 © - all rights reserved  
<https://www.phoenixcontact.com>

Phoenix Contact USA  
586 Fulling Mill Road  
Middletown, PA 17057, United States  
(+717) 944-1300  
[info@phoenixcon.com](mailto:info@phoenixcon.com)