

# ICS25-F45D9-7035 - Connection plate



1053054

<https://www.phoenixcontact.com/us/products/1053054>

Please be informed that the data shown in this PDF document is generated from our online catalog. Please find the complete data in the user documentation. Our general terms of use for downloads are valid.

DIN rail housing, ICS filler, with D-SUB 9 function cutout, width: 25 mm, height: 7.25 mm, depth: 44.9 mm, color: light gray (similar RAL 7035)



## Your advantages

- Flexible use, thanks to the modular system and unique modularity in the connection technology
- Standardized connections such as RJ45, USB, D-SUB and antenna sockets as components that can be integrated
- Optimal space utilization, as well as adaptability of design, colors, and printing
- Customized processing for any customer-specific connection technology
- Easy and fast push-in mounting of assembled printed-circuit boards, thanks to stable guide rails

## Commercial data

Item number	1053054
Packing unit	10 pc
Minimum order quantity	10 pc
Sales key	AC09
Product key	ACHAEE
GTIN	4055626678320
Weight per piece (including packing)	2.93 g
Weight per piece (excluding packing)	2.41 g
Customs tariff number	85389099
Country of origin	PL

# ICS25-F45D9-7035 - Connection plate

1053054

<https://www.phoenixcontact.com/us/products/1053054>

## Technical data

### Notes

Assembly note	Please observe the application note in the download area.
---------------	---

### Product properties

Product type	Connection plate
Housing type	DIN rail housing
Housing type	Modular housings
Housing series	ICS
Product family	ICS25
Ventilation openings present	no

### Dimensions

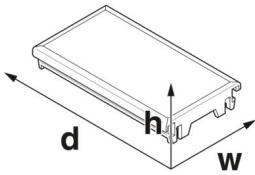
Dimensional drawing	
Width	25 mm
Height	7.25 mm
Depth	44.9 mm

### PCB design

PCB thickness	1.4 mm ... 1.8 mm
---------------	-------------------

### Material specifications

Color (Connection plate)	light gray (RAL 7035)
Material Connection plate	PA
Flammability rating according to UL 94	V0
CTI according to IEC 60112	600

### Environmental and real-life conditions

#### Vibration test

Specification	IEC 60068-2-6:2007-12
Frequency	10 - 150 - 10 Hz
Sweep speed	1 octave/min
Amplitude	0.15 mm (10 Hz ... 58.1 Hz)
Acceleration	2g (58.1 Hz ... 150 Hz)
Test duration per axis	2.5 h
Test directions	X-, Y- and Z-axis

#### Glow-wire test

# ICS25-F45D9-7035 - Connection plate



1053054

<https://www.phoenixcontact.com/us/products/1053054>

Specification	IEC 60695-2-11:2014-02
Temperature	850 °C
Time of exposure	30 s

## Thermal stability / ball thrust test

Specification	IEC 60695-10-2:2014-02
Temperature	125 °C
Test duration	1 h
Force	20 N

## Mechanical strength / tumbling barrel

Specification	IEC 60068-2-31:2008-05
Height of fall	50 cm
Frequency	50

## Shocks

Specification	IEC 60068-2-27:2008-02
Pulse shape	Half-sine
Acceleration	15g
Shock duration	11 ms
Number of shocks per direction	3
Test directions	X-, Y- and Z-axis (pos. and neg.)

## Test for substances that would hinder coating with paint or varnish

Specification	VDMA 24364:2018-05
Result	Test passed

## Ambient conditions

Max. IP code to attain	IP20
Ambient temperature (operation)	-40 °C ... 105 °C (depending on power dissipation)
Ambient temperature (storage/transport)	-40 °C ... 55 °C
Ambient temperature (assembly)	-5 °C ... 100 °C
Relative humidity (storage/transport)	80 %

## PCB data

Number of PCB holders	2
Type of PCB mount	Slot
Thickness of the PCB	1.4 mm ... 1.8 mm

## Mounting

Mounting type	Slot
---------------	------

## Packaging specifications

Outer packaging type	Resealable bag
----------------------	----------------

# ICS25-F45D9-7035 - Connection plate



1053054

<https://www.phoenixcontact.com/us/products/1053054>

## Drawings

Dimensional drawing



Schematic figure for illustrating the item dimensions. The figure is not of the desired product. For further details, refer to the product drawings in the "Downloads" tab.

# ICS25-F45D9-7035 - Connection plate



1053054

<https://www.phoenixcontact.com/us/products/1053054>

## Approvals

To download certificates, visit the product detail page: <https://www.phoenixcontact.com/us/products/1053054>



**UL Recognized**

Approval ID: E240868

# ICS25-F45D9-7035 - Connection plate



1053054

<https://www.phoenixcontact.com/us/products/1053054>

## Classifications

### ECLASS

ECLASS-13.0	27190605
ECLASS-15.0	27190605

### ETIM

ETIM 10.0	EC002779
-----------	----------

### UNSPSC

UNSPSC 21.0	31261500
-------------	----------

# ICS25-F45D9-7035 - Connection plate



1053054

<https://www.phoenixcontact.com/us/products/1053054>

## Environmental product compliance

### EU RoHS

Fulfills EU RoHS substance requirements	Yes, No exemptions
---	--------------------

### China RoHS

Environment friendly use period (EFUP)	EFUP-E
	No hazardous substances above the limits

### EU REACH SVHC

REACH candidate substance (CAS No.)	No substance above 0.1 wt%
-------------------------------------	----------------------------

### EF3.1 Climate Change

CO2e kg	0.028 kg CO2e
---------	---------------

Phoenix Contact 2026 © - all rights reserved  
<https://www.phoenixcontact.com>

Phoenix Contact USA  
586 Fulling Mill Road  
Middletown, PA 17057, United States  
(+717) 944-1300  
[info@phoenixcon.com](mailto:info@phoenixcon.com)