

FP 0,8/ 12-MV-SH 2,65 - SMD male connector, shielded

1043731

<https://www.phoenixcontact.com/us/products/1043731>

Please be informed that the data shown in this PDF document is generated from our online catalog. Please find the complete data in the user documentation. Our general terms of use for downloads are valid.

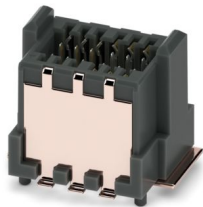

shielded SMD male connector, nominal current: 1.7 A, test voltage: 500 V AC, number of positions: 12, pitch: 0.8 mm, color: black, contact surface: Au, contact connection type: Pin, mounting: SMD soldering

Your advantages

- Gold-plated contacts ensure transfer quality remains stable over the long term
- Reliable mechanical and electrical connections, thanks to the double-sided ScaleX contact system
- Robustness: ScaleX technology for high tolerance compensation and protection of contacts
- Flexible device design: various numbers of positions, designs, and stack heights with high wipe lengths



Commercial data

| | |
|--------------------------------------|---------------|
| Item number | 1043731 |
| Packing unit | 250 pc |
| Minimum order quantity | 250 pc |
| Sales key | AA23 |
| Product key | AAWJDC |
| GTIN | 4055626616704 |
| Weight per piece (including packing) | 2.968 g |
| Weight per piece (excluding packing) | 0.48 g |
| Customs tariff number | 85366930 |
| Country of origin | CN |

FP 0,8/ 12-MV-SH 2,65 - SMD male connector, shielded



1043731

<https://www.phoenixcontact.com/us/products/1043731>

Technical data

Product properties

| | |
|---------------------------|-----------------------------|
| Product type | shielded SMD male connector |
| Product family | FP 0,8/...-MV-SH 2,65 |
| Number of positions | 12 |
| Pitch | 0.8 mm |
| Number of rows | 2 |
| Pin layout | Linear pad geometry |
| Electrical characteristic | shielded |

Electrical properties

Properties

| | |
|---------------------------|---|
| Nominal current I_N | 1.7 A IEC 60512-5-2:2002-02 (at 20°C 80-pos.) |
| Contact resistance | 15 mΩ |
| Test voltage | 500 V AC IEC 60512-4-1:2003-05 |
| Electrical characteristic | shielded |

Data transmission

| | |
|------------------------|---------|
| Data transmission rate | 16 Gbps |
|------------------------|---------|

Mounting

| | |
|---------------|---------------------|
| Mounting type | SMD soldering |
| Pin layout | Linear pad geometry |

Processing notes

| | |
|----------------------------------|------------------|
| Process | Reflow soldering |
| Moisture Sensitive Level | MSL 1 |
| Classification temperature T_C | 260 °C |
| Solder cycles in the reflow | 3 |

Material specifications

Material data - contact

| | |
|---|--|
| Note | WEEE/RoHS-compliant, free of whiskers according to IEC 60068-2-82/JEDEC JESD 201 |
| Contact material | Cu alloy |
| Surface characteristics | Selective coating |
| Metal surface contact area (top layer) | Gold (min. 0.5 μm Au) |
| Metal surface contact area (middle layer) | Nickel (1.27 μm - 4 μm Ni) |
| Metal surface soldering area (top layer) | Tin (2 μm - 6 μm Sn) |
| Metal surface soldering area (middle layer) | Nickel (1.27 μm - 4 μm Ni) |

Material data - housing

| | |
|-----------------|--------------|
| Color (Housing) | black (9005) |
|-----------------|--------------|

FP 0,8/ 12-MV-SH 2,65 - SMD male connector, shielded



1043731

<https://www.phoenixcontact.com/us/products/1043731>

| | |
|--|------|
| Insulating material | LCP |
| Insulating material group | IIIb |
| CTI according to IEC 60112 | 150 |
| Flammability rating according to UL 94 | V0 |

Notes

| | |
|---------------------------------|--|
| Notes on operation | The permissible voltage during operation depends on the application, taking into consideration the air clearances and creepage distances within the scope of insulation requirements in accordance with IEC 60664-1. |
| Details for soldering processes | The items are suitable for assembly on both sides and for overhead soldering. |

Dimensions

| | |
|---------------------|---------|
| Dimensional drawing | |
| Pitch | 0.8 mm |
| Width [w] | 8.7 mm |
| Height [h] | 7.75 mm |
| Length [l] | 6.1 mm |
| Installed height | 7.15 mm |

Application

| | |
|--|---|
| Contact cover | 0.8 mm |
| Center offset | ± 0.7 mm in longitudinal and transverse direction |
| Stack height | 7.5 mm Tolerance: +1,5 mm (in combination with Range of articles:FP 0,8/...-FV-SH 4,85) |
| | 10.5 mm Tolerance: +1,5 mm (in combination with Range of articles:FP 0,8/...-FV-SH 7,85) |
| | 13.5 mm Tolerance: +1,5 mm (in combination with Range of articles:FP 0,8/...-FV-SH 10,85) |
| Wipe length | 1.5 mm |
| Angular tolerance | ± 5 ° in longitudinal and transverse direction (when plugging in) |
| | ± 5 ° in longitudinal and transverse direction (when plugged in) |
| Axial offset in X direction (longitudinal) | ± 0.3 mm (Tolerance compensation when plugged in) |
| Axial offset in Y direction (transversal) | ± 0.3 mm (Tolerance compensation when plugged in) |

PCB design

| | |
|--------------|--------------|
| Pad geometry | 0.5 x 1.1 mm |
|--------------|--------------|

Electrical tests

Thermal test | Test group C

| | |
|---------------|-----------------------|
| Specification | IEC 60512-5-2:2002-02 |
|---------------|-----------------------|

FP 0,8/ 12-MV-SH 2,65 - SMD male connector, shielded



1043731

<https://www.phoenixcontact.com/us/products/1043731>

| | |
|---|-----------------------|
| Tested number of positions | 80 |
| Insulation resistance | |
| Specification | IEC 60512-3-1:2002-02 |
| Insulation resistance, neighboring positions | ≥ 5 GΩ |
| Air clearances and creepage distances | |
| Insulating material group | IIIb |
| Minimum value for clearance and creepage distance | 0.25 mm |

Environmental and real-life conditions

Durability test

| | |
|--|-----------------------------------|
| Specification | IEC 60512-9-1:2010-03 (following) |
| Impulse withstand voltage at sea level | 0.8 kV |
| Contact resistance R ₁ | 15 mΩ |
| Contact resistance R ₂ | 15 mΩ |
| Insertion/withdrawal cycles | 500 |
| Insulation resistance, neighboring positions | ≥ 5 GΩ |

Climatic test

| | |
|-----------------------------------|------------------------|
| Specification | IEC 60512-11-7:2003-05 |
| Corrosive stress | Method 1, 10 days |
| Power-frequency withstand voltage | 500 V AC |

Vibration test

| | |
|------------------------|--|
| Specification | IEC 60068-2-6:2007-12 |
| Frequency | 10 - 2000 - 10 Hz |
| Sweep speed | 1 octave/min |
| Amplitude | 1.5 mm (10 Hz ... 60.1 Hz) |
| Acceleration | 200 m/s ² (58 Hz ... 2000 Hz) |
| Test duration per axis | 2.5 h |
| Test directions | X-, Y- and Z-axis |

Shocks

| | |
|-----------------|-----------------------------------|
| Specification | IEC 60068-2-27:2008-02 |
| Pulse shape | Semi-sinusoidal |
| Acceleration | 490 m/s ² |
| Shock duration | 11 ms |
| Test directions | X-, Y- and Z-axis (pos. and neg.) |

Railway application: Oscillation/broadband noise

| | |
|---------------|--|
| Specification | DIN EN 50155 (VDE 0115-200):2022-06 IEC 61373:2010-05 |
| Spectrum | Long life test category 2, bogie-mounted |
| Frequency | f ₁ = 5 Hz to f ₂ = 250 Hz |
| ASD level | 6.12 (m/s ²) ² /Hz |

FP 0,8/ 12-MV-SH 2,65 - SMD male connector, shielded



1043731

<https://www.phoenixcontact.com/us/products/1043731>

| | |
|------------------------|-----------------------|
| Acceleration | 30.6 m/s ² |
| Test duration per axis | 5 h |
| Test directions | X-, Y- and Z-axis |
| Contact interruption | < 1 µs |
| Result | Test passed |

Railway application: Shocks

| | |
|--------------------------------|-------------------------------------|
| Specification | DIN EN 50155 (VDE 0115-200):2022-06 |
| | IEC 61373:2010-05 |
| Pulse shape | Semi-sinusoidal |
| Acceleration | 490 m/s ² |
| Shock duration | 11 ms |
| Number of shocks per direction | 3 |
| Test directions | X-, Y- and Z-axis (pos. and neg.) |
| Contact interruption | < 1 µs |
| Result | Test passed |

Ambient conditions

| | |
|---|-------------------|
| Ambient temperature (storage/transport) | -40 °C ... 70 °C |
| Relative humidity (storage/transport) | 30 % ... 70 % |
| Ambient temperature (assembly) | -5 °C ... 100 °C |
| Ambient temperature (operation) | -55 °C ... 125 °C |

Packaging specifications

| | |
|-----------------------------|-----------------|
| Dimensional drawing | |
| Type of packaging | 16 mm wide tape |
| [W] tape width | 16 mm |
| [W2] coil overall dimension | ≤ 22.4 mm |
| [A] coil diameter | ≤ 330 mm |
| Outer packaging type | Transparent-Bag |

FP 0,8/ 12-MV-SH 2,65 - SMD male connector, shielded



1043731

<https://www.phoenixcontact.com/us/products/1043731>

Drawings

Schematic diagram



Diagram



Type: FP 0,8/...-MV-SH 2,65 with FP 0,8/...-FV-SH 4,85

FP 0,8/ 12-MV-SH 2,65 - SMD male connector, shielded



1043731

<https://www.phoenixcontact.com/us/products/1043731>

Diagram

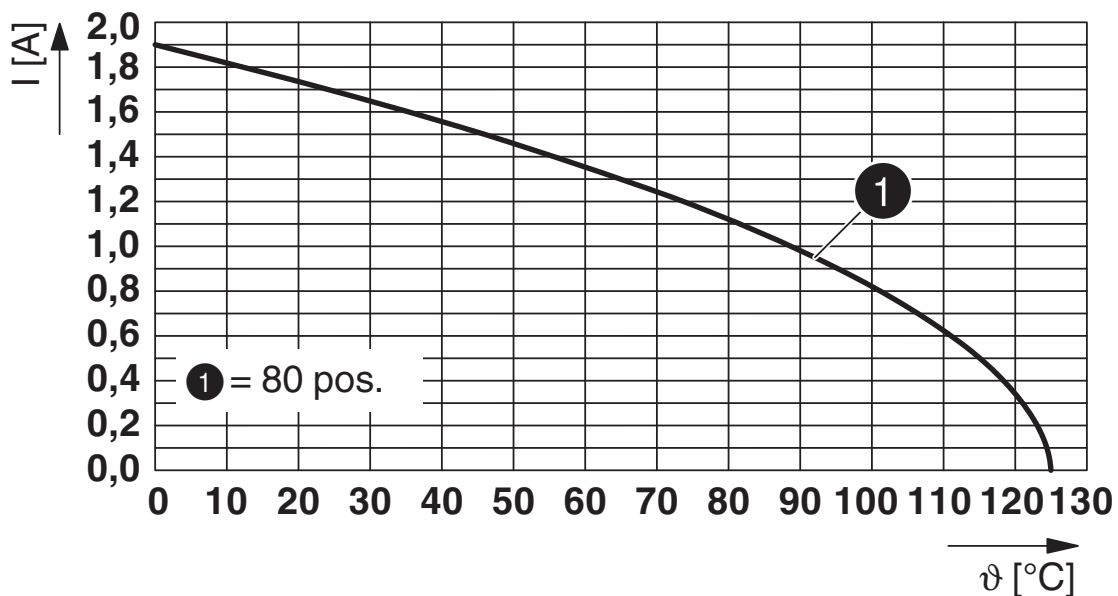

Type: FP 0,8/...-MV-SH 2,65 with FP 0,8/...-FV-SH 7,85

Diagram

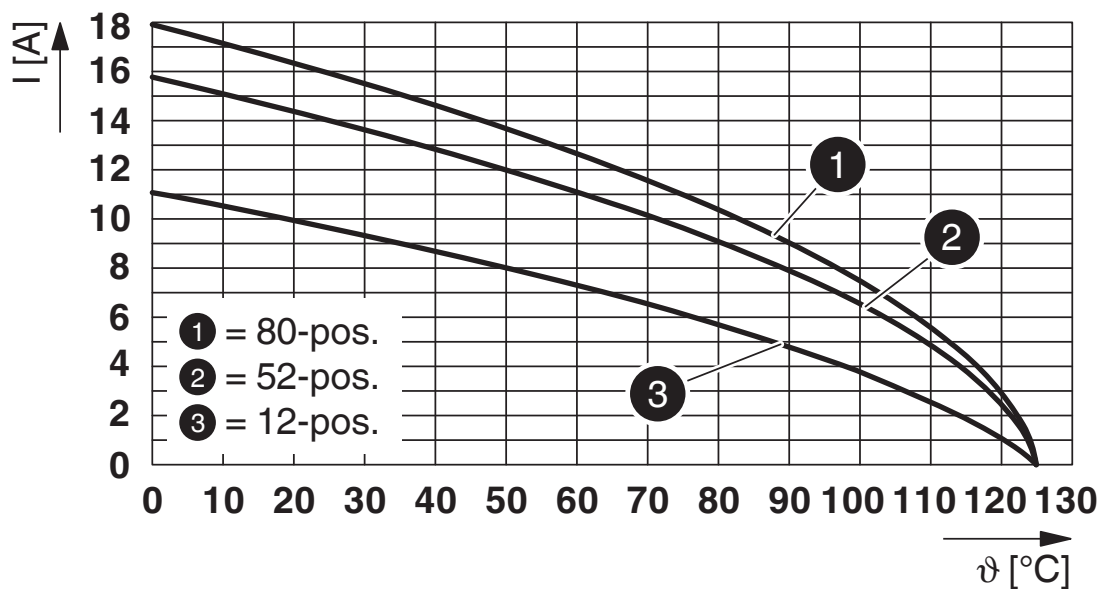

Type: FP 0,8/...-MV-SH 2,65 with FP 0,8/...-FV-SH 7,85 – shield current carrying capacity

FP 0,8/ 12-MV-SH 2,65 - SMD male connector, shielded



1043731

<https://www.phoenixcontact.com/us/products/1043731>

Diagram



Type: FP 0,8/...-MV-SH 2,65 with FP 0,8/...-FV-SH 10,85 – contacts

Diagram



Type: FP 0,8/...-MV-SH 2,65 with FP 0,8/...-FV-SH 10,85 – shielding plate

FP 0,8/ 12-MV-SH 2,65 - SMD male connector, shielded



1043731

<https://www.phoenixcontact.com/us/products/1043731>

Approvals

To download certificates, visit the product detail page: <https://www.phoenixcontact.com/us/products/1043731>



cULus Recognized

Approval ID: E118976-20190703

FP 0,8/ 12-MV-SH 2,65 - SMD male connector, shielded



1043731

<https://www.phoenixcontact.com/us/products/1043731>

Classifications

ECLASS

| | |
|-------------|----------|
| ECLASS-13.0 | 27460201 |
| ECLASS-15.0 | 27460201 |

ETIM

| | |
|-----------|----------|
| ETIM 10.0 | EC002637 |
|-----------|----------|

UNSPSC

| | |
|-------------|----------|
| UNSPSC 21.0 | 39121400 |
|-------------|----------|

FP 0,8/ 12-MV-SH 2,65 - SMD male connector, shielded



1043731

<https://www.phoenixcontact.com/us/products/1043731>

Environmental product compliance

EU RoHS

| | |
|---|--------------------|
| Fulfills EU RoHS substance requirements | Yes, No exemptions |
|---|--------------------|

China RoHS

| | |
|--|--|
| Environment friendly use period (EFUP) | EFUP-E |
| | No hazardous substances above the limits |

EU REACH SVHC

| | |
|-------------------------------------|----------------------------|
| REACH candidate substance (CAS No.) | No substance above 0.1 wt% |
|-------------------------------------|----------------------------|

Phoenix Contact 2026 © - all rights reserved
<https://www.phoenixcontact.com>

Phoenix Contact USA
586 Fulling Mill Road
Middletown, PA 17057, United States
(+717) 944-1300
info@phoenixcon.com