

NBC-M12MSD/ 5,0-93C/R4AC - Network cable



1038731

<https://www.phoenixcontact.com/us/products/1038731>

Please be informed that the data shown in this PDF document is generated from our online catalog. Please find the complete data in the user documentation. Our general terms of use for downloads are valid.



Network cable, PROFINET CAT5 (100 Mbps), EtherCAT® CAT5 (100 Mbps), 4-position, PUR halogen-free, green RAL 6018, shielded (Advanced Shielding Technology), Plug straight M12, coding: D / IP67, on Plug straight RJ45 / IP20, cable length: 5 m

Commercial data

Item number	1038731
Packing unit	1 pc
Minimum order quantity	1 pc
Sales key	BF04
Product key	AF1CJN
GTIN	4055626593029
Weight per piece (including packing)	346.2 g
Weight per piece (excluding packing)	414.1 g
Customs tariff number	85444290
Country of origin	PL

1038731

<https://www.phoenixcontact.com/us/products/1038731>

Technical data

Product properties

Product type	Data cable preassembled
Application	Standard
Sensor type	PROFINET
Number of positions	4
Shielded	yes

Insulation characteristics

Overvoltage category	I
Degree of pollution	2

Interfaces

Bus system	PROFINET
Signal type/category	PROFINET CAT5 (IEC 11801), 100 Mbps EtherCAT® CAT5 (IEC 11801), 100 Mbps

Signaling

Status display	no
Status display present	no

Electrical properties

Nominal voltage U_N	48 V AC
	60 V DC
Nominal current I_N	1 A
Transmission medium	Copper
Transmission speed	100 Mbps
Transmission characteristics (category)	CAT5 (IEC 11801:2002)

Material specifications

Flammability rating according to UL 94	V2
--	----

Connector

Connection 1

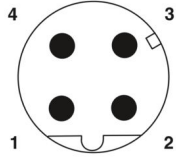
Dimensional drawing	 <p>Pin assignment M12 male connector, 4-pos., D-coded, male side</p>
Type	M12 Plug, straight, 4-position, shielded (Advanced Shielding Technology), Keying: D

NBC-M12MSD/ 5,0-93C/R4AC - Network cable



1038731

<https://www.phoenixcontact.com/us/products/1038731>

Number of positions	4
Shielded	yes
Shielding	Advanced Shielding Technology
Signal type/category	EtherCAT® CAT5 (IEC 11801), 100 Mbps PROFINET CAT5 (IEC 11801)
Insertion/withdrawal cycles	≥ 100
Insulation resistance	≥ 100 MΩ
Overvoltage category	II
Degree of pollution	3
Tightening torque	0.4 Nm
Material Contact	CuSn
Material Contact surface	Ni/Au
Material Contact carrier	PA 6.6
Material Screw connection	Die-cast zinc, nickel-plated
Material Grip body	TPU, hardly inflammable, self-extinguishing
Material Seal	FKM
Flammability rating according to UL 94	V0
Degree of protection	IP65 IP67
Ambient temperature (operation)	-25 °C ... 85 °C
Standard designation	M12 connector
Standards/regulations	IEC 61076-2-101

Connection 2

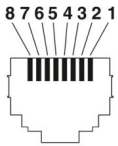
Dimensional drawing	 <p>Connector pin assignment plug RJ45</p>
Type	RJ45, straight
Signal type/category	PROFINET CAT5 (IEC 11801), 100 Mbps EtherCAT® CAT5 (IEC 11801)
Insertion/withdrawal cycles	≥ 750
Insulation resistance	≥ 100 MΩ
Overvoltage category	I
Degree of pollution	2
Material Contact	CuSn
Material Contact surface	Ni/Au
Material Contact carrier	PA
Material Housing	PA

NBC-M12MSD/ 5,0-93C/R4AC - Network cable



1038731

<https://www.phoenixcontact.com/us/products/1038731>

Color (Housing)	black
Flammability rating according to UL 94	V2
Degree of protection	IP20
Ambient temperature (operation)	-25 °C ... 80 °C

Cable/line

Cable length	5 m
--------------	-----

PROFINET drag chain CAT5 [93C]

Dimensional drawing	
UL AWM Style	20233 (80°C/300 V)
Number of positions	4
Shielded	yes
Cable type	PROFINET drag chain CAT5 [93C]
Conductor structure	1x4xAWG22/7, SF/TQ
AWG signal line	22
Conductor cross-section	4x 0.34 mm ²
Wire diameter incl. insulation	1.5 mm ±0.05 mm
External cable diameter	6.50 mm ±0.2 mm
Outer sheath, material	PUR
External sheath, color	green RAL 6018
Conductor material	Tin-plated Cu litz wires
Material wire insulation	PE
Single wire, color	white, yellow, blue, orange
Overall twist	Star quad
Optical shield covering	85 %
Insulation resistance	≥ 500 MΩ*km
Loop resistance	≤ 120.00 Ω/km
Wave impedance	100 Ω ±15 Ω (at 1 ... 100 MHz)
Nominal voltage, cable	≤ 300 V
Test voltage Core/Core	2000 V (50 Hz, 1 min.)
Test voltage Core/Shield	2000.00 V (50 Hz, 1 min.)
Minimum bending radius, fixed installation	5 x D
Minimum bending radius, flexible installation	7.5 x D
Dynamic load capacity (bending)	Max. bending cycles: 3000000, Bending radius: 200 mm, Traversing path: 10 m, Traversing rate: 4 m/s, Acceleration: 4 m/s ²
Dynamic load capacity (torsion)	Torsion: ±30 °/m

NBC-M12MSD/ 5,0-93C/R4AC - Network cable



1038731

<https://www.phoenixcontact.com/us/products/1038731>

Halogen-free	according to IEC 60754-1
Flame resistance	according to IEC 60332-1-2
	in accordance with UN ECE-R 118.03
	according to CSA C 22.2 No. 210-FT1
Resistance to oil	in accordance with DIN EN 60811-404
Other resistance	UV resistant
Special properties	Flexible cable conduit capable
Ambient temperature (operation)	-40 °C ... 70 °C (cable, fixed installation)
	-40 °C ... 70 °C (Cable, flexible installation)

Standards and regulations

M12

Standard designation	M12 connector
Standards/specifications	IEC 61076-2-101

Drawings

Dimensional drawing



Plug, M12 x 1, straight, shielded

Dimensional drawing

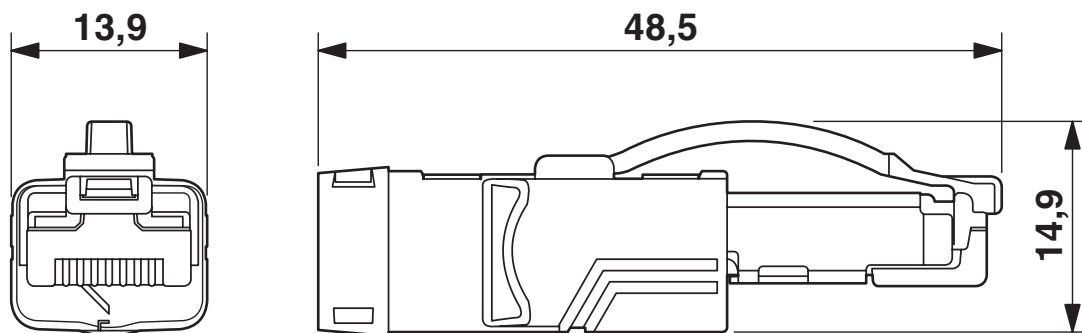

RJ45 connector, IP20

NBC-M12MSD/ 5,0-93C/R4AC - Network cable

1038731

<https://www.phoenixcontact.com/us/products/1038731>



Schematic diagram



Pin assignment M12 male connector, 4-pos., D-coded, male side

Schematic diagram



Connector pin assignment plug RJ45

NBC-M12MSD/ 5,0-93C/R4AC - Network cable



1038731

<https://www.phoenixcontact.com/us/products/1038731>

Circuit diagram

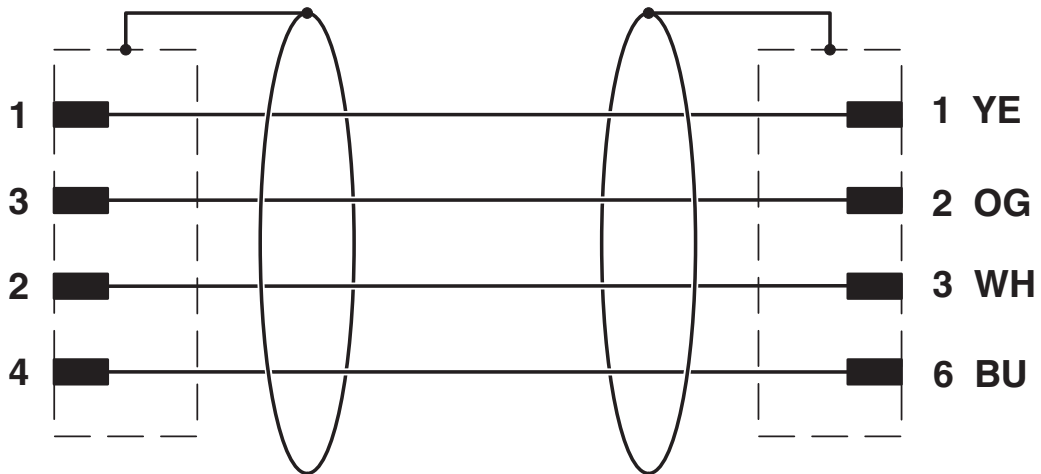

Contact assignment of the M12 and RJ45 plug

NBC-M12MSD/ 5,0-93C/R4AC - Network cable



1038731

<https://www.phoenixcontact.com/us/products/1038731>

Approvals

To download certificates, visit the product detail page: <https://www.phoenixcontact.com/us/products/1038731>

 cULus Listed Approval ID: E335024				
	Nominal voltage U_N	Nominal current I_N	Cross section AWG	Cross section mm^2
keine				
	60 V	0.5 A	-	-

NBC-M12MSD/ 5,0-93C/R4AC - Network cable



1038731

<https://www.phoenixcontact.com/us/products/1038731>

Classifications

ECLASS

ECLASS-13.0	27060307
ECLASS-15.0	27060307

ETIM

ETIM 10.0	EC001855
-----------	----------

UNSPSC

UNSPSC 21.0	26121600
-------------	----------

NBC-M12MSD/ 5,0-93C/R4AC - Network cable



1038731

<https://www.phoenixcontact.com/us/products/1038731>

Environmental product compliance

EU RoHS

Fulfills EU RoHS substance requirements	Yes, No exemptions
---	--------------------

China RoHS

Environment friendly use period (EFUP)	EFUP-E
	No hazardous substances above the limits

EU REACH SVHC

REACH candidate substance (CAS No.)	No substance above 0.1 wt%
-------------------------------------	----------------------------

Phoenix Contact 2026 © - all rights reserved
<https://www.phoenixcontact.com>

Phoenix Contact USA
586 Fulling Mill Road
Middletown, PA 17057, United States
(+717) 944-1300
info@phoenixcon.com