

CC1,5-TS-2,10FPE S/T AU - Crimp contact



1029400

<https://www.phoenixcontact.com/us/products/1029400>

Please be informed that the data shown in this PDF document is generated from our online catalog. Please find the complete data in the user documentation. Our general terms of use for downloads are valid.



Crimp contact, Socket, turned, contact diameter: 1.5 mm, connection cross section: 1.5 mm² ... 1.5 mm², AWG 14...14, contact material: CuZn

Commercial data

Item number	1029400
Packing unit	25 pc
Minimum order quantity	25 pc
Sales key	BF34
Product key	AF2CJB
GTIN	4055626531427
Weight per piece (including packing)	0.531 g
Weight per piece (excluding packing)	0.529 g
Customs tariff number	85366990
Country of origin	DE

CC1,5-TS-2,10FPE S/T AU - Crimp contact



1029400

<https://www.phoenixcontact.com/us/products/1029400>

Technical data

Mounting

Mounting type	Snap in
---------------	---------

Product properties

Product type	Crimp contact
Contact material type	turned

Connection data

Connection technology

Contact connection type	Socket
Connection method	Crimp connection

Conductor connection

Connection cross section (flexible)	1.5 mm ² ... 1.5 mm ²
Connection cross section AWG (flexible)	14 ... 14

Material specifications

Material Contact	CuZn
Material Contact surface	Ni/Au

Dimensions

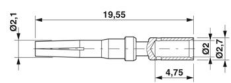
Dimensional drawing	
Diameter (Contact diameter)	1.5 mm

Mechanical properties

Mechanical data

Insertion/withdrawal cycles	≥ 100
-----------------------------	-------

Environmental and real-life conditions

Ambient conditions

Ambient temperature (operation)	-40 °C ... 85 °C
---------------------------------	------------------

CC1,5-TS-2,10FPE S/T AU - Crimp contact



1029400

<https://www.phoenixcontact.com/us/products/1029400>

Drawings

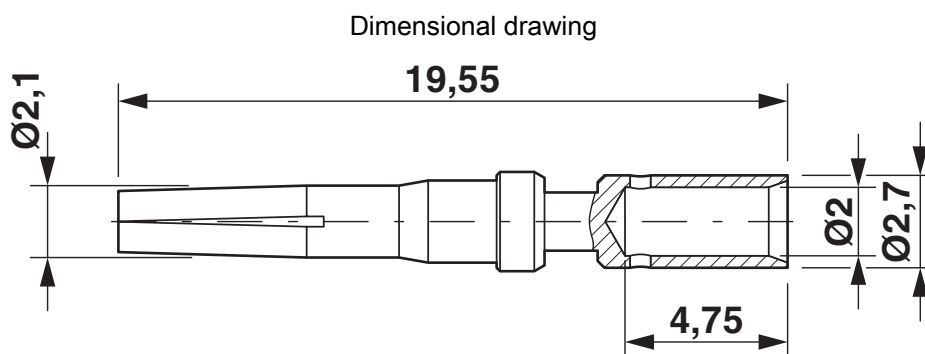

Crimp contact, diameter: 1.5 mm

CC1,5-TS-2,10FPE S/T AU - Crimp contact



1029400

<https://www.phoenixcontact.com/us/products/1029400>

Classifications

ECLASS

ECLASS-13.0	27440204
ECLASS-15.0	27440204

ETIM

ETIM 10.0	EC000796
-----------	----------

UNSPSC

UNSPSC 21.0	39121500
-------------	----------

CC1,5-TS-2,10FPE S/T AU - Crimp contact



1029400

<https://www.phoenixcontact.com/us/products/1029400>

Environmental product compliance

EU RoHS

Fulfills EU RoHS substance requirements	Yes, No exemptions
---	--------------------

China RoHS

Environment friendly use period (EFUP)	EFUP-E
	No hazardous substances above the limits

EU REACH SVHC

REACH candidate substance (CAS No.)	No substance above 0.1 wt%
-------------------------------------	----------------------------

EF3.1 Climate Change

CO2e kg	0.428 kg CO2e
---------	---------------

Phoenix Contact 2026 © - all rights reserved
<https://www.phoenixcontact.com>

Phoenix Contact USA
586 Fulling Mill Road
Middletown, PA 17057, United States
(+717) 944-1300
info@phoenixcon.com