

DMCC 0,5/14-ST-2,54 - PCB connector

1027616

<https://www.phoenixcontact.com/us/products/1027616>

Please be informed that the data shown in this PDF document is generated from our online catalog. Please find the complete data in the user documentation. Our general terms of use for downloads are valid.

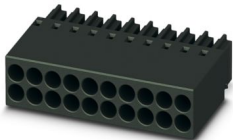

The figure shows a 10-pos. version with 20 contacts

PCB connector, nominal cross section: 0.75 mm², color: black, nominal current: 6 A, rated voltage (III/2): 160 V, contact surface: Au, contact connection type: Socket, number of potentials: 28, number of rows: 2, number of positions: 14, number of connections: 28, product range: DMCC 0,5/..-ST, pitch: 2.54 mm, connection method: Crimp connection, conductor/PCB connection direction: 0 °, plug-in system: COMBICON DFMC 0,5, locking: without, mounting method: without, type of packaging: packed in cardboard

Your advantages

- Cost-effective connection of crimped conductors in large quantities
- Gold-plated contacts ensure transfer quality remains stable over the long term
- Contacts arranged in a double row enable high packing density in a compact area
- Tools for manual and automatic crimping available as an option

Commercial data

Item number	1027616
Packing unit	50 pc
Minimum order quantity	50 pc
Note	Made to order (non-returnable)
Sales key	AA01
Product key	AAACDA
GTIN	4055626522760
Weight per piece (including packing)	2.674 g
Weight per piece (excluding packing)	2.674 g
Customs tariff number	85366990
Country of origin	CN

DMCC 0,5/14-ST-2,54 - PCB connector



1027616

<https://www.phoenixcontact.com/us/products/1027616>

Technical data

Product properties

Product type	PCB connector
Product family	DMCC 0,5/...-ST
Product line	COMBICON Connectors XS
Number of positions	14
Pitch	2.54 mm
Number of connections	28
Number of rows	2
Number of potentials	28

Electrical properties

Properties

Nominal current I_N	6 A
Nominal voltage U_N	160 V
Contact resistance	2.2 m Ω
Rated voltage (III/3)	160 V
Rated surge voltage (III/3)	2.5 kV
Rated voltage (III/2)	160 V
Rated surge voltage (III/2)	2.5 kV
Rated voltage (II/2)	320 V
Rated surge voltage (II/2)	2.5 kV
Note on change in voltage	With a cable cross-section of AWG 18 or 0.75 mm ² , the rated insulation voltage is reduced to 63 V with a rated surge voltage of 1.5 kV and a pollution degree of 1 or 2, depending on the insulation thickness of the cable used.

Connection data

Connection technology

Type	Standard
Connector system	COMBICON DFMC 0,5
Nominal cross section	0.75 mm ²
Contact connection type	Socket

Interlock

Locking type	without
Mounting type	without

Conductor connection

Connection method	Crimp connection
Conductor/PCB connection direction	0 °
Conductor cross-section flexible	0.14 mm ² ... 0.75 mm ² (Maximum external diameter of the insulation 1.9 mm)

DMCC 0,5/14-ST-2,54 - PCB connector

1027616

<https://www.phoenixcontact.com/us/products/1027616>

Conductor cross-section AWG	26 ... 18 (Maximum external diameter of the insulation 1.9 mm)
Stripping length	4.1 mm ... 4.5 mm

Material specifications

Material data - contact

Contact material	Cu alloy
Metal surface contact area (top layer)	Gold (Au)

Material data - housing

Color (Housing)	black (9005)
Insulating material	PA
Insulating material group	I
CTI according to IEC 60112	600
Flammability rating according to UL 94	V0
Glow wire flammability index GWFI according to EN 60695-2-12	850
Glow wire ignition temperature GWIT according to EN 60695-2-13	775
Temperature for the ball pressure test according to EN 60695-10-2	125 °C

Dimensions

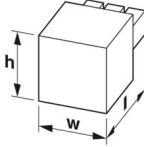
Dimensional drawing	
Pitch	2.54 mm
Width [w]	36.06 mm
Height [h]	6.49 mm
Length [l]	16 mm

Notes

Note on the contact	The information on the basic material and the finish properties of the crimp contacts is to be found in the E-Shop in the technical data for the respective crimp contact.
Note on application	All laboratory tests are performed in combination with the crimp contacts specified as accessories.
Note on application	The current depends on the crimp contact and conductor cross-section used.
Note on application	The corresponding crimp contacts are to be found in the "Accessories" tab.
Note on application	The crimp contacts may only be processed with approved crimping tools.
Note on the contact	These connectors conform to DIN EN 61984, connectors without switching power (COC). When used for their intended purpose, they must not be plugged in or disconnected live or under load.

DMCC 0,5/14-ST-2,54 - PCB connector



1027616

<https://www.phoenixcontact.com/us/products/1027616>

Note on change in voltage	With a cable cross-section of AWG 18 or 0.75 mm ² , the rated insulation voltage is reduced to 63 V with a rated surge voltage of 1.5 kV and a pollution degree of 1 or 2, depending on the insulation thickness of the cable used.
---------------------------	--

Mechanical tests

Tensile strength of crimp connections

Result	Test passed
Conductor cross-section/conductor type/tractive force setpoint/actual value	0.14 mm ² / flexible / > 18 N

Insertion and withdrawal forces

Specification	IEC 60512-13-2:2006-02
Result	Test passed
No. of cycles	100
Insertion strength per pos. approx.	2 N
Withdraw strength per pos. approx.	2 N

Resistance of inscriptions

Specification	IEC 60068-2-70:1995-12
Result	Test passed

Polarization and coding

Specification	IEC 60512-13-5:2006-02
Result	Test passed

Visual inspection

Specification	IEC 60512-1-1:2002-02
Result	Test passed

Dimension check

Specification	IEC 60512-1-2:2002-02
Result	Test passed

Environmental and real-life conditions

Durability test

Specification	IEC 60512-9-1:2010-03
Impulse withstand voltage at sea level	2.95 kV
Contact resistance R ₁	2.2 mΩ
Contact resistance R ₂	2.2 mΩ
Contact resistance R ₂ 2nd level	2.4 mΩ
Insertion/withdrawal cycles	100
Insulation resistance, neighboring positions	> 5 MΩ

Climatic test

Specification	DIN 50018:2013-05
Corrosive stress	1.0 dm ³ SO ₂ on 300 dm ³ /40 °C/1 cycle

DMCC 0,5/14-ST-2,54 - PCB connector



1027616

<https://www.phoenixcontact.com/us/products/1027616>

Thermal stress	105 °C/168 h
Power-frequency withstand voltage	1.39 kV

Vibration test

Specification	IEC 60068-2-6:2007-12
Frequency	10 - 150 - 10 Hz
Sweep speed	1 octave/min
Amplitude	0.35 mm (10 Hz ... 60.1 Hz)
Acceleration	5g (60.1 Hz ... 150 Hz)
Test duration per axis	2 h
Test directions	X-, Y- and Z-axis

Shocks

Specification	IEC 60068-2-27:2008-02
Pulse shape	Semi-sinusoidal
Acceleration	30g
Shock duration	18 ms
Test directions	X-, Y- and Z-axis (pos. and neg.)

Railway application: Oscillation/broadband noise

Specification	DIN EN 50155 (VDE 0115-200):2022-06 IEC 61373:2010-05
Spectrum	Long life test category 1, class B, body mounted
Frequency	$f_1 = 5 \text{ Hz}$ to $f_2 = 150 \text{ Hz}$
ASD level	0.964 (m/s ²)/Hz
Acceleration	0.572 g
Test duration per axis	5 h
Test directions	X-, Y- and Z-axis
Contact interruption	< 1 μs
Result	Test passed

Railway application: Shocks

Specification	DIN EN 50155 (VDE 0115-200):2022-06 IEC 61373:2010-05
Pulse shape	Semi-sinusoidal
Acceleration	30g
Shock duration	18 ms
Number of shocks per direction	3
Test directions	X-, Y- and Z-axis (pos. and neg.)
Contact interruption	< 1 μs
Result	Test passed

Ambient conditions

Ambient temperature (storage/transport)	-40 °C ... 70 °C
Relative humidity (storage/transport)	30 % ... 70 %
Ambient temperature (assembly)	-5 °C ... 100 °C

DMCC 0,5/14-ST-2,54 - PCB connector



1027616

<https://www.phoenixcontact.com/us/products/1027616>

Ambient temperature (operation)	-55 °C ... 105 °C (dependent on the derating curve)
---------------------------------	---

Electrical tests

Thermal test | Test group C

Specification	IEC 60512-5-1:2002-02
Tested number of positions	16

Insulation resistance

Specification	IEC 60512-3-1:2002-02
Insulation resistance, neighboring positions	> 5 MΩ

Air clearances and creepage distances |

Specification	IEC 60664-1:2007-04
Insulating material group	I
Comparative tracking index (IEC 60112)	CTI 600
Rated insulation voltage (III/3)	160 V
Rated surge voltage (III/3)	2.5 kV
minimum clearance value - non-homogenous field (III/3)	1.5 mm
minimum creepage distance (III/3)	2 mm
Rated insulation voltage (III/2)	160 V
Rated surge voltage (III/2)	2.5 kV
minimum clearance value - non-homogenous field (III/2)	1.5 mm
minimum creepage distance (III/2)	1.5 mm
Rated insulation voltage (II/2)	320 V
Rated surge voltage (II/2)	2.5 kV
minimum clearance value - non-homogenous field (II/2)	1.5 mm
minimum creepage distance (II/2)	1.6 mm

Packaging specifications

Type of packaging	packed in cardboard
-------------------	---------------------

DMCC 0,5/14-ST-2,54 - PCB connector



1027616

<https://www.phoenixcontact.com/us/products/1027616>

Drawings

Diagram



Type: DMCC 0.5/...-ST-2.54 with DMC 0.5/...-G1-2.54 P...THR R...

DMCC 0,5/14-ST-2,54 - PCB connector





1027616

<https://www.phoenixcontact.com/us/products/1027616>

Approvals

To download certificates, visit the product detail page: <https://www.phoenixcontact.com/us/products/1027616>

 cULus Recognized Approval ID: E60425-19920306				
	Nominal voltage U_N	Nominal current I_N	Cross section AWG	Cross section mm^2
B				
Factory wiring	150 V	6 A	26 - 18	-
D				
Factory wiring	150 V	6 A	26 - 18	-

 VDE report with production monitoring Approval ID: 40042389				
	Nominal voltage U_N	Nominal current I_N	Cross section AWG	Cross section mm^2
keine				
	160 V	6 A	-	0.14 - 0.75

DMCC 0,5/14-ST-2,54 - PCB connector



1027616

<https://www.phoenixcontact.com/us/products/1027616>

Classifications

ECLASS

ECLASS-13.0	27460202
ECLASS-15.0	27460202

ETIM

ETIM 10.0	EC002638
-----------	----------

UNSPSC

UNSPSC 21.0	39121400
-------------	----------

DMCC 0,5/14-ST-2,54 - PCB connector



1027616

<https://www.phoenixcontact.com/us/products/1027616>

Environmental product compliance

EU RoHS

Fulfills EU RoHS substance requirements	Yes, No exemptions
---	--------------------

China RoHS

Environment friendly use period (EFUP)	EFUP-E
	No hazardous substances above the limits

EU REACH SVHC

REACH candidate substance (CAS No.)	No substance above 0.1 wt%
-------------------------------------	----------------------------

EF3.1 Climate Change

CO2e kg	0.016 kg CO2e
---------	---------------

Phoenix Contact 2026 © - all rights reserved
<https://www.phoenixcontact.com>

Phoenix Contact USA
586 Fulling Mill Road
Middletown, PA 17057, United States
(+717) 944-1300
info@phoenixcon.com