

TMC 73D 07A - Miniature Circuit Breaker



1020088

<https://www.phoenixcontact.com/us/products/1020088>

Please be informed that the data shown in this PDF document is generated from our online catalog. Please find the complete data in the user documentation. Our general terms of use for downloads are valid.



Miniature Circuit Breaker, 3-position, use: Supplementary Protector (UL 1077), for protection against overcurrent up to a short-circuit current of 7.5 kA. Supplementary protector; OC; UG-EA,B,D., tripping characteristic: D, mounting type: NS 35/..., rated current: 7 A

Product description

CCC marking on the product is only present on products purchased from Phoenix Contact China.

Your advantages

- Can be used worldwide due to international approvals
- Suitable for various grid types, as it is available in 1-, 2-, 3-pos. versions
- Ideally coordinated protection due to various tripping characteristics and a wide selection of nominal currents
- Reduced inventory because of suitability for AC and DC applications
- Optional accessories enable remote control and monitoring

Commercial data

Item number	1020088
Packing unit	4 pc
Minimum order quantity	1 pc
Sales key	CL09
Product key	CLA126
GTIN	4055626509709
Weight per piece (including packing)	222.222 g
Weight per piece (excluding packing)	351 g
Customs tariff number	85362010
Country of origin	CN

TMC 73D 07A - Miniature Circuit Breaker



1020088

<https://www.phoenixcontact.com/us/products/1020088>

Technical data

Product properties

Product type	Circuit breakers
Product family	TMC 7
Type	DIN rail module, one-piece
Number of positions	3
Mechanical service life	20000
Special properties	Supplementary Protector (UL 1077), for protection against overcurrent up to a short-circuit current of 7.5 kA. Supplementary protector; OC; UG- EA,B,D.

Electrical properties

Service life electrical	6000
-------------------------	------

General

Operating voltage	277 V AC (277/480Y, 240D)
Rated current I_N	7 A
Tripping method	TM (thermal-magnetic)
Rated short-circuit switching capacity I_{cn}	7.5 kA (277/480Y, 240D)
Fuse	D
Contact switching type	none

Connection data

Conductor cross-section rigid	1 mm ² ... 35 mm ²
Cross section AWG	18 ... 2 (converted acc. to IEC)
Conductor cross-section flexible	1 mm ² ... 35 mm ²
Connection method	Screw connection
Tightening torque, min	2 Nm
Tightening torque	2 Nm
Stripping length	11 mm ... 12 mm
Conductor cross-section flexible max.	35 mm ²
Conductor cross-section, rigid max.	35 mm ²
Conductor cross-section flexible	1 mm ² ... 35 mm ²
Conductor cross-section rigid	1 mm ² ... 35 mm ²
Conductor cross-section AWG	18 ... 2

Dimensions

Dimensional drawing	
Width	52.9 mm

TMC 73D 07A - Miniature Circuit Breaker



1020088

<https://www.phoenixcontact.com/us/products/1020088>

Height	84.3 mm
Depth	76.6 mm (incl. DIN rail 7.5 mm)

Material specifications

Color	light gray (RAL 7035)
	light gray (RAL 7035)

Environmental and real-life conditions

Ambient conditions

Degree of protection	IP20
Ambient temperature (operation)	-35 °C ... 70 °C
Humidity test	48 h, 95% RH, 40°C (IEC 60068-2-78)
Shock (operation)	30g (11 ms) (IEC 60068-2-11, test Ea)
Vibration (operation)	±0,38 mm (10 Hz ... 57 Hz), 5g (57 Hz ... 500 Hz) (Sinusoidal test to IEC 60068-2-6, Test Fc. 10 frequency cycles per axis)

Standards and regulations

Standards/specifications	UL 1077
Standards/specifications	IEC 60947-2

Mounting

Mounting type	NS 35/...
---------------	-----------

TMC 73D 07A - Miniature Circuit Breaker



1020088

<https://www.phoenixcontact.com/us/products/1020088>

Drawings

Dimensional drawing

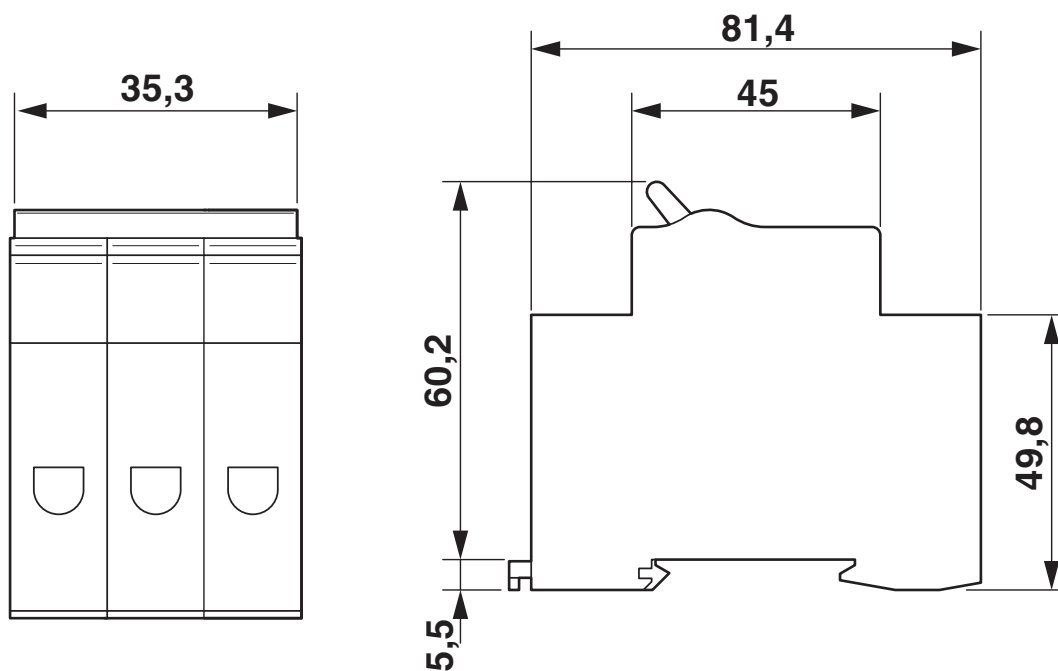

TMC 73D 07A - Miniature Circuit Breaker

1020088

<https://www.phoenixcontact.com/us/products/1020088>



Diagram



TMC 73D 07A - Miniature Circuit Breaker



1020088

<https://www.phoenixcontact.com/us/products/1020088>

Approvals

To download certificates, visit the product detail page: <https://www.phoenixcontact.com/us/products/1020088>



cUL Recognized
Approval ID: FILE E 140459



UL Recognized
Approval ID: FILE E 140459



TÜV Rheinland
Approval ID: R 50531587



CCC
Approval ID: 2024010307673885

TMC 73D 07A - Miniature Circuit Breaker



1020088

<https://www.phoenixcontact.com/us/products/1020088>

Classifications

ECLASS

ECLASS-13.0	27140401
ECLASS-15.0	27140401

ETIM

ETIM 10.0	EC003538
-----------	----------

UNSPSC

UNSPSC 21.0	39121410
-------------	----------

TMC 73D 07A - Miniature Circuit Breaker



1020088

<https://www.phoenixcontact.com/us/products/1020088>

Environmental product compliance

EU RoHS

Fulfills EU RoHS substance requirements	Yes, No exemptions
---	--------------------

China RoHS

Environment friendly use period (EFUP)	EFUP-E
	No hazardous substances above the limits

EU REACH SVHC

REACH candidate substance (CAS No.)	No substance above 0.1 wt%
-------------------------------------	----------------------------

EF3.1 Climate Change

CO2e kg	5.826 kg CO2e
---------	---------------

Phoenix Contact 2026 © - all rights reserved
<https://www.phoenixcontact.com>

Phoenix Contact USA
586 Fulling Mill Road
Middletown, PA 17057, United States
(+717) 944-1300
info@phoenixcon.com