

# UT 6-TMC M 12A - Thermal-magnetic device circuit breaker

0916611

<https://www.phoenixcontact.com/us/products/0916611>

Please be informed that the data shown in this PDF document is generated from our online catalog. Please find the complete data in the user documentation. Our general terms of use for downloads are valid.

Thermal-magnetic circuit breaker, 1-pos., for DIN rail mounting



## Your advantages

- Simple feed-in due to bridging capability using CLIPLINE complete accessories
- High system availability, thanks to easy resetting
- Quick and easy identification with large-area marking options
- The right device for every application, thanks to a nominal current range of 0.5 to 16 A
- Space savings of 30 % compared to miniature circuit breakers owing to the compact width of 12.3 mm

## Commercial data

Item number	0916611
Packing unit	6 pc
Minimum order quantity	6 pc
Sales key	CL16
Product key	CLA122
GTIN	4046356449472
Weight per piece (including packing)	64.51 g
Weight per piece (excluding packing)	64.51 g
Customs tariff number	85362010
Country of origin	CZ

# UT 6-TMC M 12A - Thermal-magnetic device circuit breaker



0916611

<https://www.phoenixcontact.com/us/products/0916611>

## Technical data

### Product properties

Product type	Thermomagnetic device circuit breakers
Product family	UT 6-TMC
Type	DIN rail module, one-piece
Number of positions	1
Number of connections	2
Number of rows	1
No. of channels	1
Potentials	1

### Insulation characteristics

Overvoltage category	II
Degree of pollution	2

### Electrical properties

Fuse type	Automatic device
Maximum power dissipation for nominal condition	$\leq 1.57 \text{ VA}$

### General

Operating voltage	50 V AC ... 264 V AC (48 - 62 Hz)
	5 V DC ... 30.8 V DC
Rated voltage	240 V AC (50/60 Hz)
	28 V DC
	240 V AC (50/60 Hz)
	28 V DC
Rated insulation voltage $U_i$	440 V AC
Rated current $I_N$	12 A
Rated surge voltage	2.8 kV
Insulation resistance $R_{iso}$	$> 100 \text{ M}\Omega$ (main contact)
Type of actuation	S type
Tripping method	TM (thermal-magnetic)
Tripping level	Trip-free mechanism (positive)
Device resistance	10.9 m $\Omega$
Required backup fuse	25 A
Rated short-circuit switching capacity $I_{cn}$	200 A (240 V AC)
	400 A (28 V DC)
Dielectric strength	2000 V
Switching cycles, max.	6000 (at $1 \times I_n$ )
	50 (at $1.5 \times I_n$ )
	40 (at $6 \times I_n$ )
Fuse	M1 (normal blow)
Power dissipation	$\leq 1.57 \text{ VA}$

# UT 6-TMC M 12A - Thermal-magnetic device circuit breaker



0916611

<https://www.phoenixcontact.com/us/products/0916611>

Contact switching type	none
Indicator/remote signaling	
Connection name	Auxiliary contact

## Connection data

Nominal cross section	6.00 mm <sup>2</sup>
Rated cross section AWG	8
Connection method	Screw connection

## Level 1 above 1 below 1

Connection method	Screw connection
Screw thread	M4
Tightening torque	1.5 ... 1.8 Nm
Stripping length	12 mm
Conductor cross-section rigid	0.2 mm <sup>2</sup> ... 10 mm <sup>2</sup>
Cross section AWG	24 ... 8 (converted acc. to IEC)
Conductor cross-section flexible	0.2 mm <sup>2</sup> ... 10 mm <sup>2</sup>
Conductor cross-section, flexible [AWG]	24 ... 8 (converted acc. to IEC)
Conductor cross-section flexible (ferrule without plastic sleeve)	0.25 mm <sup>2</sup> ... 6 mm <sup>2</sup>
Flexible conductor cross-section (ferrule with plastic sleeve)	0.25 mm <sup>2</sup> ... 6 mm <sup>2</sup>
2 conductors with same cross section, rigid	0.2 mm <sup>2</sup> ... 2.5 mm <sup>2</sup>
2 conductors with same cross section, flexible	0.2 mm <sup>2</sup> ... 2.5 mm <sup>2</sup>
2 conductors with same cross section, flexible, with ferrule without plastic sleeve	0.25 mm <sup>2</sup> ... 1.5 mm <sup>2</sup>
2 conductors with the same cross section, flexible, with TWIN ferrule with plastic sleeve	0.5 mm <sup>2</sup> ... 4 mm <sup>2</sup>
Nominal cross section	6 mm <sup>2</sup>
Nominal current	12 A
Nominal voltage	240 V AC 28 V DC

## Main contact

Connection method	Screw connection
Screw thread	M4
Tightening torque	1.5 Nm ... 1.8 Nm
Stripping length	12 mm
Conductor cross-section flexible	0.2 mm <sup>2</sup> ... 10 mm <sup>2</sup>
Conductor cross-section rigid	0.2 mm <sup>2</sup> ... 10 mm <sup>2</sup>
Conductor cross-section AWG	24 ... 8
2 conductors with the same cross section, flexible, with TWIN ferrule with plastic sleeve	0.5 mm <sup>2</sup> ... 4 mm <sup>2</sup>
Conductor cross-section, flexible, with ferrule, with plastic sleeve	0.25 mm <sup>2</sup> ... 6 mm <sup>2</sup>
Conductor cross-section, flexible, with ferrule, without plastic sleeve	0.25 mm <sup>2</sup> ... 6 mm <sup>2</sup>

## Dimensions

# UT 6-TMC M 12A - Thermal-magnetic device circuit breaker



0916611

<https://www.phoenixcontact.com/us/products/0916611>

Width	12.3 mm
Height	85.5 mm
Depth	89.5 mm

## Material specifications

Color	gray (RAL 7042)
Flammability rating according to UL 94	V-0
Insulating material	PA66

## Mechanical properties

### Mechanical data

Open side panel	No
-----------------	----

## Environmental and real-life conditions

### Ambient conditions

Degree of protection	IP40 (Actuation area)
	IP20 (Connection area)
Ambient temperature (operation)	-30 °C ... 60 °C
Altitude	2000 m (acc. to EN 60934)

## Standards and regulations

Standards/specifications	EN 60934
Standards/specifications	UL 1077
Standards/specifications	CSA 22.2
Note	No. 235

## Mounting

Mounting type	DIN rail: 35 mm
---------------	-----------------

# UT 6-TMC M 12A - Thermal-magnetic device circuit breaker

0916611

<https://www.phoenixcontact.com/us/products/0916611>

## Drawings

Application drawing



Application drawing

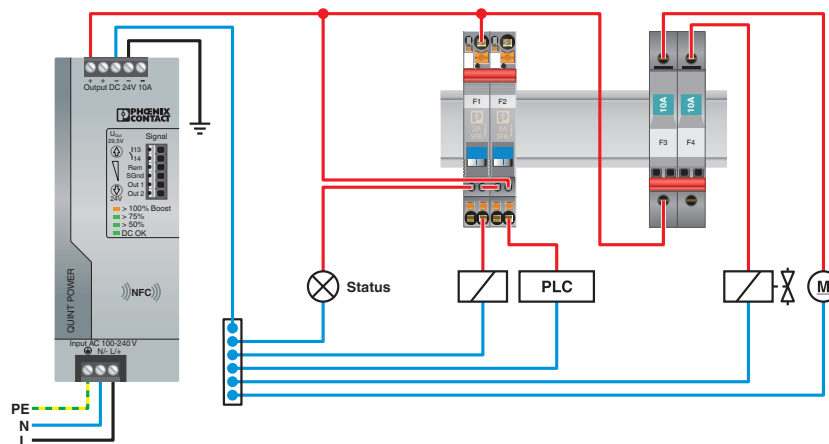

# UT 6-TMC M 12A - Thermal-magnetic device circuit breaker



0916611

<https://www.phoenixcontact.com/us/products/0916611>

Diagram



Trigger characteristic

Diagram



Operating current correction factor

# UT 6-TMC M 12A - Thermal-magnetic device circuit breaker

0916611

<https://www.phoenixcontact.com/us/products/0916611>

Block diagram



# UT 6-TMC M 12A - Thermal-magnetic device circuit breaker



0916611

<https://www.phoenixcontact.com/us/products/0916611>

## Approvals

To download certificates, visit the product detail page: <https://www.phoenixcontact.com/us/products/0916611>



**cUL Recognized**  
Approval ID: FILE E 140459



**UL Recognized**  
Approval ID: FILE E 140459



**VDE Zeichengenehmigung**  
Approval ID: 40028127



**CSA**  
Approval ID: 250505

# UT 6-TMC M 12A - Thermal-magnetic device circuit breaker



0916611

<https://www.phoenixcontact.com/us/products/0916611>

## Classifications

### ECLASS

ECLASS-13.0	27140401
ECLASS-15.0	27140401

### ETIM

ETIM 10.0	EC003538
-----------	----------

### UNSPSC

UNSPSC 21.0	39121400
-------------	----------

# UT 6-TMC M 12A - Thermal-magnetic device circuit breaker



0916611

<https://www.phoenixcontact.com/us/products/0916611>

## Environmental product compliance

### EU RoHS

Fulfills EU RoHS substance requirements	Yes, No exemptions
---	--------------------

### China RoHS

Environment friendly use period (EFUP)	EFUP-E
	No hazardous substances above the limits

### EU REACH SVHC

REACH candidate substance (CAS No.)	No substance above 0.1 wt%
-------------------------------------	----------------------------

### EF3.1 Climate Change

CO2e kg	0.996 kg CO2e
---------	---------------

Phoenix Contact 2026 © - all rights reserved  
<https://www.phoenixcontact.com>

Phoenix Contact USA  
586 Fulling Mill Road  
Middletown, PA 17057, United States  
(+717) 944-1300  
[info@phoenixcon.com](mailto:info@phoenixcon.com)