

TMC 1 F1 200 16,0A - Thermal-magnetic device circuit breaker



0914361

<https://www.phoenixcontact.com/us/products/0914361>

Please be informed that the data shown in this PDF document is generated from our online catalog. Please find the complete data in the user documentation. Our general terms of use for downloads are valid.



Thermal-magnetic circuit breaker, 1-pos., fast blow, 1 N/C contact, with universal foot for mounting on NS 32 or NS 35

Commercial data

Item number	0914361
Packing unit	1 pc
Note	Made to order (non-returnable)
Sales key	CL04
Product key	CLA121
GTIN	4017918009045
Weight per piece (including packing)	67.9 g
Weight per piece (excluding packing)	67.9 g
Customs tariff number	85362010
Country of origin	DE

TMC 1 F1 200 16,0A - Thermal-magnetic device circuit breaker



0914361

<https://www.phoenixcontact.com/us/products/0914361>

Technical data

Product properties

Product type	Thermomagnetic device circuit breakers
Product family	TMC
Type	DIN rail module, one-piece
Number of positions	1
Number of connections	4
Number of rows	2

Insulation characteristics

Overvoltage category	II
Degree of pollution	2

Electrical properties

Fuse type	Automatic device
-----------	------------------

General

Rated voltage	65 V DC
Rated current I_N	16 A
Rated surge voltage	2.5 kV
Insulation resistance R_{iso}	> 100 M Ω (500 V DC)
Auxiliary circuit	240 V AC / 1 A (Low-induction) 65 V AC / 1 A (Low-induction)
Tripping method	TM (thermal-magnetic)
Device resistance	0.02 Ω
Rated short-circuit switching capacity I_{cn}	2500 A (32 V DC)
Short-circuit switching capacity	2000 A (UL 1077: 65 V DC)
Dielectric strength	3000 V AC (Actuation area) 3000 V AC (Main to auxiliary circuit)
Switching cycles, max.	10000 (At $1 \times I_N$, inductive)
Fuse	F1 (fast blow)
Contact switching type	1 N/C contact

Connection data

Main contact

Connection method	Screw connection
Screw thread	M3
Tightening torque	0.6 ... 0.8 Nm
Stripping length	12 mm
Internal cylindrical gage	A3
Conductor cross-section rigid	0.2 mm ² ... 6 mm ²

TMC 1 F1 200 16,0A - Thermal-magnetic device circuit breaker



0914361

<https://www.phoenixcontact.com/us/products/0914361>

Cross section AWG	24 ... 10 (converted acc. to IEC)
Conductor cross-section flexible	0.2 mm ² ... 4 mm ²
Conductor cross-section flexible (ferrule without plastic sleeve)	0.25 mm ² ... 4 mm ²
Flexible conductor cross-section (ferrule with plastic sleeve)	0.25 mm ² ... 2.5 mm ²
2 conductors with same cross section, rigid	0.2 mm ² ... 0.75 mm ²
2 conductors with same cross section, flexible	0.2 mm ² ... 0.75 mm ²
2 conductors with same cross section, flexible, with ferrule without plastic sleeve	0.25 mm ² ... 1 mm ²
2 conductors with the same cross section, flexible, with TWIN ferrule with plastic sleeve	0.5 mm ² ... 2.5 mm ²
Nominal current	16 A

Auxiliary contact

Connection method	Screw connection
Screw thread	M3
Tightening torque	0.6 ... 0.8 Nm
Stripping length	12 mm
Internal cylindrical gage	A1
Conductor cross-section rigid	0.2 mm ² ... 2.5 mm ²
Cross section AWG	24 ... 14 (converted acc. to IEC)
Conductor cross-section flexible	0.2 mm ² ... 1.5 mm ²
Conductor cross-section flexible (ferrule without plastic sleeve)	0.25 mm ² ... 2.5 mm ²
Flexible conductor cross-section (ferrule with plastic sleeve)	0.25 mm ² ... 1.5 mm ²
2 conductors with same cross section, rigid	0.2 m ² ... 0.75 m ²
2 conductors with same cross section, flexible	0.2 m ² ... 0.75 mm ²
2 conductors with same cross section, flexible, with ferrule without plastic sleeve	0.25 mm ² ... 0.5 mm ²
2 conductors with the same cross section, flexible, with TWIN ferrule with plastic sleeve	0.5 mm ² ... 0.75 mm ²

Dimensions

Dimensional drawing	
Width	12.5 mm
Height	82.5 mm
Depth	96 mm

Material specifications

Flammability rating according to UL 94	V-2
--	-----

TMC 1 F1 200 16,0A - Thermal-magnetic device circuit breaker



0914361

<https://www.phoenixcontact.com/us/products/0914361>

Insulating material group	II
Insulating material	PA66

Mechanical properties

Mechanical data

Open side panel	No
-----------------	----

Environmental and real-life conditions

Ambient conditions

Degree of protection	IP30 (Actuation area)
	IP20 (Connection area)
Ambient temperature (operation)	-30 °C ... 60 °C
Humidity test	240 h, 95 % RH, 40 °C

Standards and regulations

Standards/specifications	EN 60934
Standards/specifications	UL 1077

Mounting

Mounting type	DIN rail: 35 mm
---------------	-----------------

TMC 1 F1 200 16,0A - Thermal-magnetic device circuit breaker



0914361

<https://www.phoenixcontact.com/us/products/0914361>

Drawings

Dimensional drawing

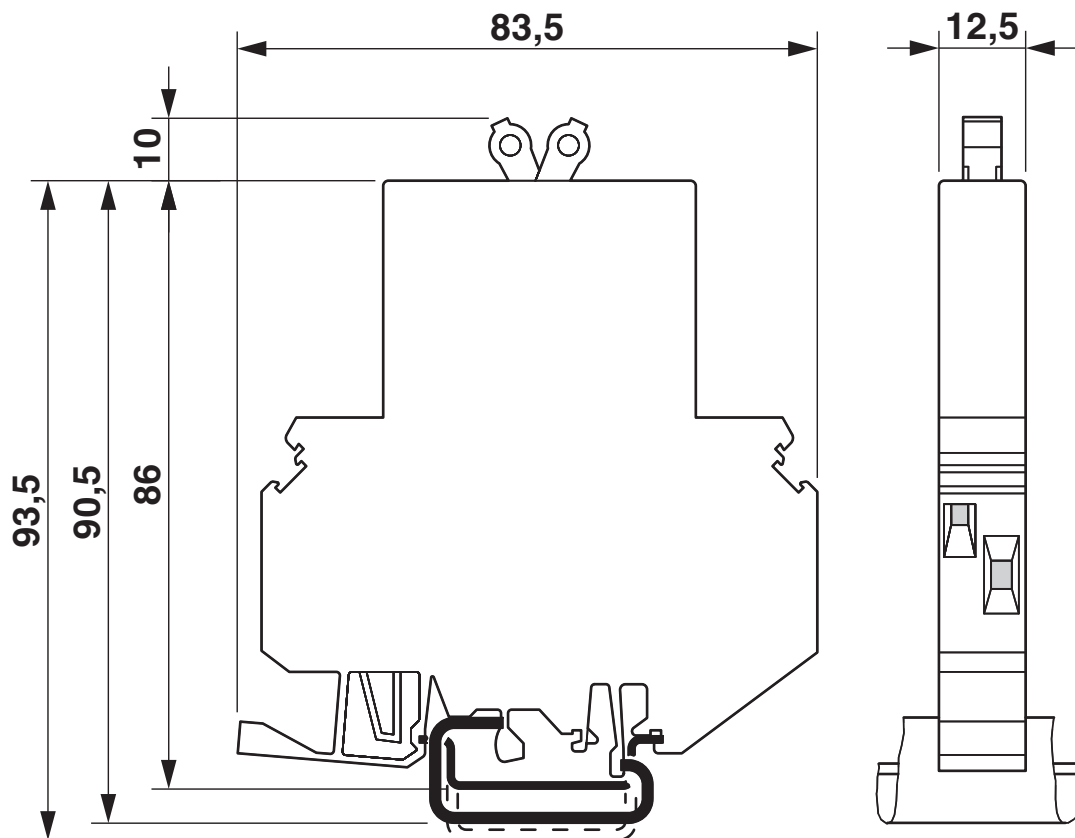

TMC 1 F1 200 16,0A - Thermal-magnetic device circuit breaker



0914361

<https://www.phoenixcontact.com/us/products/0914361>

Diagram

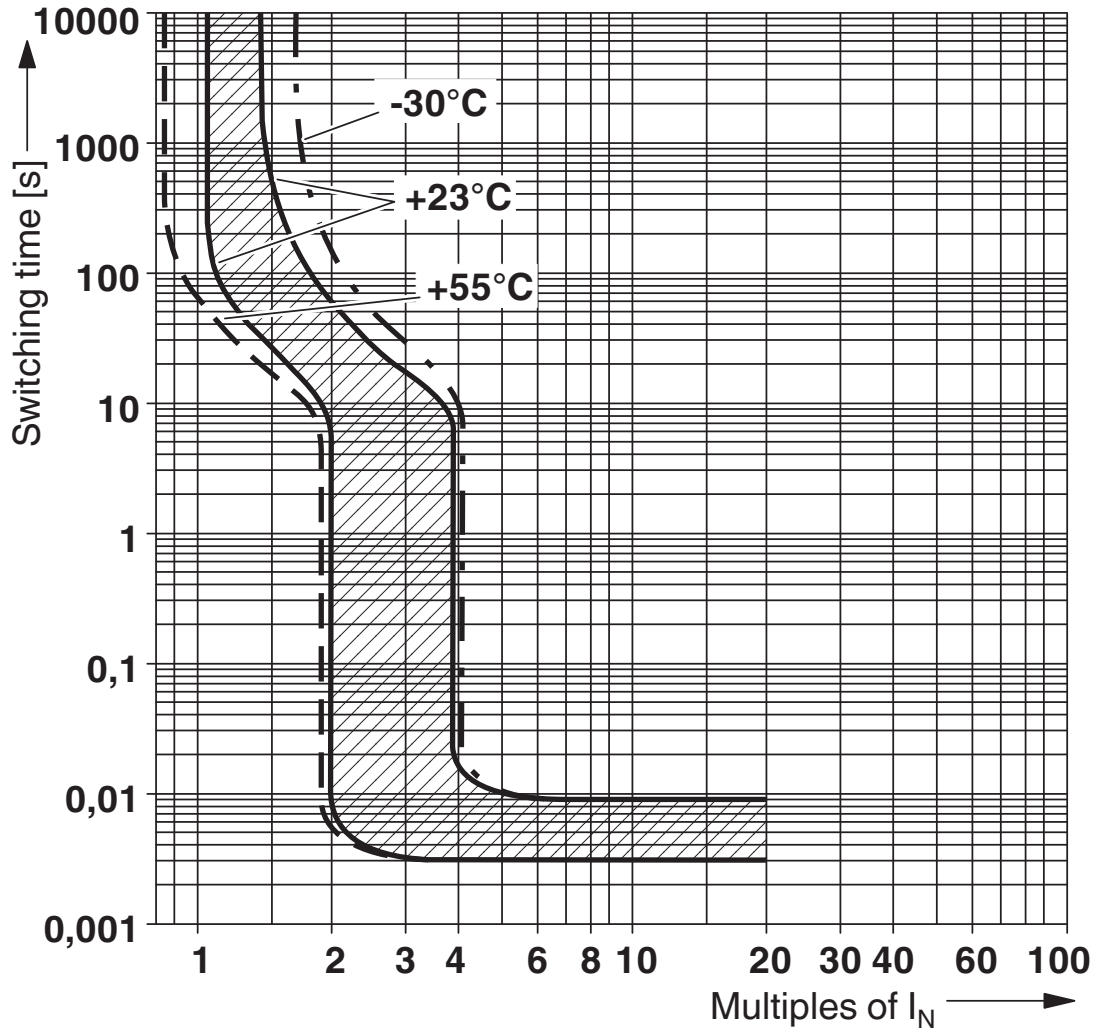

Phoenix Contact 2026 © - all rights reserved
<https://www.phoenixcontact.com>

Phoenix Contact USA
586 Fulling Mill Road
Middletown, PA 17057, United States
(+717) 944-1300
info@phoenixcon.com