

# C S6 A 300X300X210 - Empty enclosure



0899087

<https://www.phoenixcontact.com/us/products/0899087>

Please be informed that the data shown in this PDF document is generated from our online catalog. Please find the complete data in the user documentation. Our general terms of use for downloads are valid.



Empty enclosure, material: Stainless steel, 316L/1.4404, surface resistance: brushed, silver-colored, 300 mm x 300 mm x 210 mm, type of locking: Door with replaceable hinge, scope of supply - ATD: Door hinge with quarter turn locking, Mounting panel, Double-bit key, Fixing angle with mounting screws, M12 grounding bolts, affixed externally, Installation notes, Door hinge with quarter turn locking

## Your advantages

- Innovative product range of high-quality stainless steel housings as the basis for individual terminal boxes
- Reduced assembly and approval effort thanks to ready-equipped terminal boxes
- Flange plates possible on four sides of the housing, including seal protection
- Housing adjustments using threads, bore holes, and rectangular cutouts with consideration given to normative specifications

## Commercial data

Item number	0899087
Packing unit	1 pc
Minimum order quantity	1 pc
Note	Made to order (non-returnable)
Sales key	BH91
Product key	BH9112
GTIN	4046356928496
Weight per piece (including packing)	6.34 kg
Weight per piece (excluding packing)	6.34 kg
Customs tariff number	94032080
Country of origin	DE

# C S6 A 300X300X210 - Empty enclosure



0899087

<https://www.phoenixcontact.com/us/products/0899087>

## Technical data

### Product properties

Product type	Terminal box
Scope of supply	Door hinge with quarter turn locking
	Mounting panel
	Double-bit key
	Fixing angle with mounting screws
	M12 grounding bolts, affixed externally
	Installation notes

### Insulation characteristics

Protection class	I
------------------	---

### Electrical properties

Maximum power dissipation	17 W (T6 up to 40 °C)
	10.6 W (T6 up to 55 °C)
	6.3 W (T6 up to 65 °C)
	23.4 W (T5 up to 40 °C)
	17 W (T5 up to 55 °C)
	12.8 W (T5 up to 65 °C)
	27.6 W (T4 up to 40 °C)
	13.3 W (T4 up to 55 °C)
17 W (T4 up to 65 °C)	

### Dimensions

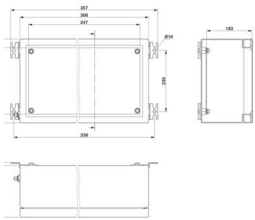
Dimensional drawing	
Width	300 mm
Height	300 mm
Depth	210 mm
Clearance width, maximum DIN rail length	244 mm
Max. material thickness	1.5 mm

### Material specifications

Color	silver-colored
Material	Stainless steel, 316L/1.4404
Seal material	Silicon
Surface characteristics	brushed

# C S6 A 300X300X210 - Empty enclosure



0899087

<https://www.phoenixcontact.com/us/products/0899087>

Note	240 grain
------	-----------

## Mechanical properties

### General

Type of locking (GRP)	Door with replaceable hinge Quarter turn locking with two-way key bit
-----------------------	---

## Environmental and real-life conditions

### Degree of protection (IP code)

Degree of protection	IP66
----------------------	------

### Ambient conditions

Ambient temperature (operation)	-55 °C ... 135 °C
---------------------------------	-------------------

## Mounting

Assembly note	External fixing clips
---------------	-----------------------

# C S6 A 300X300X210 - Empty enclosure



0899087

<https://www.phoenixcontact.com/us/products/0899087>

## Drawings

Dimensional drawing

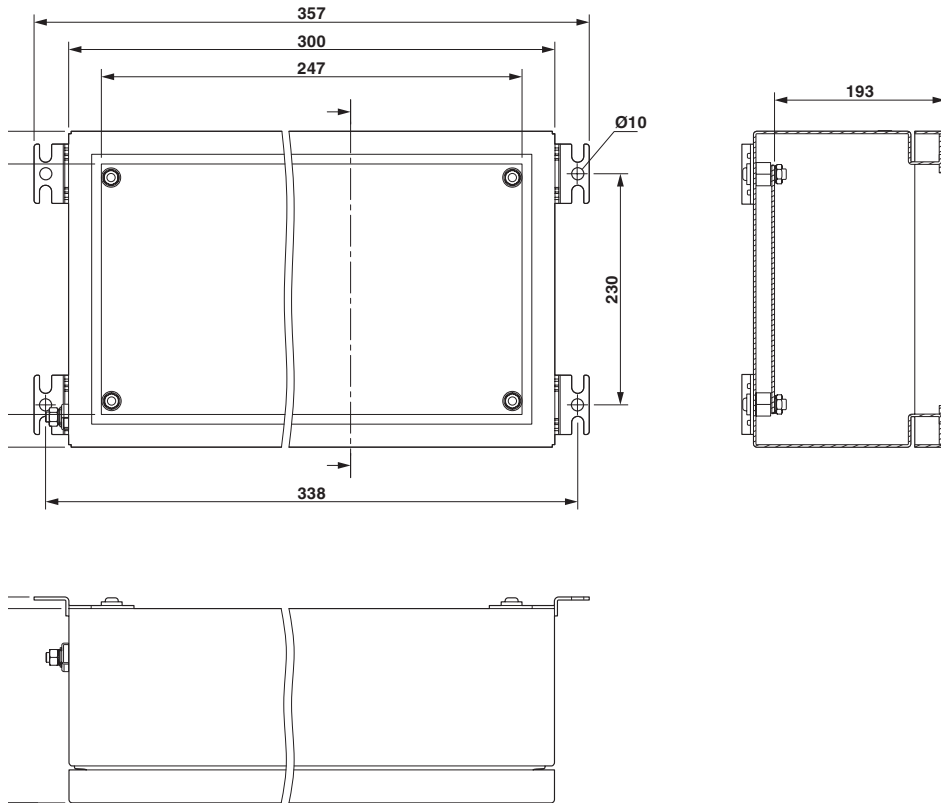

# C S6 A 300X300X210 - Empty enclosure

0899087

<https://www.phoenixcontact.com/us/products/0899087>



Schematic diagram



# C S6 A 300X300X210 - Empty enclosure



0899087

<https://www.phoenixcontact.com/us/products/0899087>

## Classifications

### ECLASS

ECLASS-13.0	27180101
ECLASS-15.0	27180101

### ETIM

ETIM 10.0	EC000261
-----------	----------

### UNSPSC

UNSPSC 21.0	31261500
-------------	----------

# C S6 A 300X300X210 - Empty enclosure



0899087

<https://www.phoenixcontact.com/us/products/0899087>

## Environmental product compliance

### EU RoHS

Fulfills EU RoHS substance requirements	Yes, No exemptions
---	--------------------

### EU REACH SVHC

REACH candidate substance (CAS No.)	No substance above 0.1 wt%
-------------------------------------	----------------------------

Phoenix Contact 2026 © - all rights reserved

<https://www.phoenixcontact.com>

Phoenix Contact USA  
586 Fulling Mill Road  
Middletown, PA 17057, United States  
(+717) 944-1300  
[info@phoenixcon.com](mailto:info@phoenixcon.com)